

# FUNAI

## ZV427FX4

## ZV427FX4 A

### DVD Recorder/VCR LINE-IN RECORDING (No Tuner)

### Owner's Manual

INSTRUCCIONES EN ESPAÑOL INCLUIDAS.



© 2013 Funai Electric Co., Ltd.

Introduction

Connections

Basic Setup

Recording

Playback

Editing

Function Setup

VCR Functions

Others

Español

# SAFETY INFORMATION

The model and serial numbers of this unit may be found on the cabinet.  
You should record and retain those numbers for future reference.

Model No.: \_\_\_\_\_

Serial No.: \_\_\_\_\_

**WARNING:** TO REDUCE THE RISK OF FIRE OR ELECTRIC SHOCK, DO NOT EXPOSE THIS APPARATUS TO RAIN OR MOISTURE. APPARATUS SHALL NOT BE EXPOSED TO DRIPPING OR SPLASHING AND NO OBJECTS FILLED WITH LIQUIDS, SUCH AS VASES, SHALL BE PLACED ON THE APPARATUS.



**CAUTION**  
**RISK OF ELECTRIC SHOCK**  
**DO NOT OPEN**



## CAUTION:

TO REDUCE THE RISK OF ELECTRIC SHOCK, DO NOT REMOVE COVER (OR BACK). NO USER SERVICEABLE PARTS INSIDE. REFER SERVICING TO QUALIFIED SERVICE PERSONNEL.



The lightning flash with arrowhead symbol, within an equilateral triangle, is intended to alert the user to the presence of uninsulated "dangerous voltage" within the product's enclosure that may be of sufficient magnitude to constitute a risk of electric shock to persons.



The exclamation point within an equilateral triangle is intended to alert the user to the presence of important operating and maintenance (servicing) instructions in the literature accompanying the appliance.

The important note and rating are located on the rear or bottom of the cabinet.

The symbol for CLASS II (Double Insulation)

## IMPORTANT SAFETY INSTRUCTIONS

1. Read these instructions.
2. Keep these instructions.
3. Heed all warnings.
4. Follow all instructions.
5. Do not use this apparatus near water.
6. Clean only with dry cloth.
7. Do not block any ventilation openings. Install in accordance with the manufacturer's instructions.
8. Do not install near any heat sources such as radiators, heat registers, stoves, or other apparatus (including amplifiers) that produce heat.
9. Do not defeat the safety purpose of the polarized or grounding-type plug. A polarized plug has two blades with one wider than the other. A grounding type plug has two blades and a third grounding prong. The wide blade or the third prong are provided for your safety. If the provided plug does not fit into your outlet, consult an electrician for replacement of the obsolete outlet.
10. Protect the power cord from being walked on or pinched particularly at plugs, convenience receptacles, and the point where they exit from the apparatus.
11. Only use attachments/accessories specified by the manufacturer.
12. Use only with the cart, stand, tripod, bracket, or table specified by the manufacturer, or sold with the apparatus. When a cart is used, use caution when moving the cart/apparatus combination to avoid injury from tip-over. 
13. Unplug this apparatus during lightning storms or when unused for long periods of time.
14. Refer all servicing to qualified service personnel. Servicing is required when the apparatus has been damaged in any way, such as power-supply cord or plug is damaged, liquid has been spilled or objects have fallen into the apparatus, the apparatus has been exposed to rain or moisture, does not operate normally, or has been dropped.

### FCC WARNING

This equipment may generate or use radio frequency energy. Changes or modifications to this equipment may cause harmful interference unless the modifications are expressly approved in the manual. The user could lose the authority to operate this equipment if an unauthorized change or modification is made.

### RADIO-TV INTERFERENCE

This equipment has been tested and found to comply with the limits for a Class B digital device, pursuant to Part 15 of the FCC Rules. These limits are designed to provide reasonable protection against harmful interference in a residential installation. This equipment generates, uses, and can radiate radio frequency energy and, if not installed and used in accordance with the instructions, may cause harmful interference to radio communications. However, there is no guarantee that interference will not occur in a particular installation. If this equipment does cause harmful interference to radio or television reception, which can be determined by turning the equipment off and on, the user is encouraged to try to correct the interference by one or more of the following measures:

- 1) Reorient or relocate the receiving antenna.
- 2) Increase the separation between the equipment and receiver.
- 3) Connect the equipment into an outlet on a circuit different from that to which the receiver is connected.
- 4) Consult the dealer or an experienced radio/TV technician for help.

Disconnect the mains plug to shut off when find trouble or not in use. The mains plug shall remain readily operable.

# SAFETY INFORMATION

**CAUTION:** Danger of explosion if battery is incorrectly replaced. Replace only with the same or equivalent type.  
**WARNING:** Batteries (Battery pack or battery installed) shall not be exposed to excessive heat such as sunshine, fire or the like.

## LASER SAFETY

This apparatus is classified as a CLASS 1 LASER PRODUCT.  
This apparatus employs a laser. Only a qualified service person should remove the cover or attempt to service this apparatus, due to possible eye injury.

**CAUTION:** Use of controls or adjustments or performance of procedures other than those specified herein may result in hazardous radiation exposure.



## IMPORTANT COPYRIGHT INFORMATION

Unauthorized copying, broadcasting, public performance and lending of discs are prohibited. This item incorporates copy protection technology that is protected by U.S. patents and other intellectual property rights of Rovi Corporation. Reverse engineering and disassembly are prohibited.

Do not place the unit on the furniture that is capable of being tilted by a child and an adult leaning, pulling, standing or climbing on it. A falling unit can cause serious injury or even death.

Never use a gas duster on this unit.  
The gas trapped inside of this unit may cause ignition and explosion.

## To Avoid the Hazards of Electrical Shock and Fire

- Do not handle the power cord with wet hands.
- Do not pull on the power cord when disconnecting it from an AC outlet. Grasp it by the plug.
- Do not put your fingers or objects into the unit.

## Location and Handling

- Do not install the unit in direct sunlight, near strong magnetic fields, or in a place subject to dust or strong vibration.
- Avoid a place with drastic temperature changes.
- Install the unit in a horizontal and stable position. Do not place anything directly on top or bottom of the unit. Depending on your external devices, noise or disturbance of the picture and/or sound may be generated if the unit is placed too close to them. In this case, please ensure enough space between the external devices and the unit.
- Depending on the environment, the temperature of this unit may increase slightly. This is not a malfunction.
- Be sure to remove the disc and unplug the AC power cord from the outlet before carrying the unit.

## Dew Condensation Warning

- Dew condensation may form inside the unit in the following conditions. If so, do not use this unit at least for a few hours until its inside gets dry.
  - The unit is moved from a cold place to a warm place.
  - Under conditions of high humidity.
  - After heating a cold room.

## Note about Recycling

- This unit's packaging materials are recyclable and can be reused. Please dispose of any materials in accordance with your local recycling regulations.
- Batteries should never be thrown away or incinerated but disposed of in accordance with your local regulations concerning chemical wastes.
- For product recycling information, please visit - [www.funaiamerica.com](http://www.funaiamerica.com).



## Notice for Progressive Scan Output

- Consumers should note that not all high definition television sets are fully compatible with this product and may cause artifacts to be displayed in the picture. In case of picture problems with 525(480) progressive scan output, it is recommended that the user switch the connection to the 'standard definition' output. If there are questions regarding your TV set compatibility with this 525p(480p) DVD player, please contact our customer service center.

# SAFETY INFORMATION

## Supplied Accessories

remote control (NC180UD/NC180UH)  
with batteries (AA, 1.5V x 2)

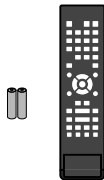

RCA audio/video cables

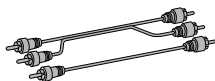

owner's manual



quick guide



## Maintenance

### Servicing

- Please refer to relevant topics on "TROUBLESHOOTING" on pages 84-87 before returning the product.
- If this unit becomes inoperative, do not try to correct the problem by yourself. There are no user-serviceable parts inside. Turn the unit to the standby mode, unplug the power plug and please call our help line mentioned on the front page to locate an Authorized Service Center.

### Cleaning the cabinet

- Wipe the front panel and other exterior surfaces of the unit with a soft cloth.
- Never use a solvent, thinner, benzene or alcohol to clean the unit. Do not spray insecticide liquid near the unit. Such chemicals may discolor the surface or damage the unit.

### Cleaning discs

- When a disc becomes dirty, clean it with a cleaning cloth. Wipe the disc from the center to out. Do not wipe in a circular motion.
- Do not use solvents such as benzene, thinner, commercially available cleaners, detergent, abrasive cleaning agents or antistatic spray intended for analog records.

### Cleaning the disc lens

- If this unit still does not perform properly although you refer to the relevant sections and to "TROUBLESHOOTING" in this owner's manual, the laser optical pickup unit may be dirty. Consult your dealer or an Authorized Service Center for inspection and cleaning of the laser optical pickup unit.

### Disc handling

- Handle the discs so that fingerprints and dust do not adhere to the surfaces of the discs.
- Always store the disc in its protective case when it is not used.

### Auto head cleaning

- Automatically cleans video heads as you insert or remove a cassette, so you can see a clear picture.
  - Playback picture may become blurred or interrupted while the TV program reception is clear. Dirt accumulated on the video heads after a long period of use or the usage of rental or worn tapes can cause this problem. If a streaky or snowy picture appears during playback, the video heads in your unit may need to be cleaned.
1. Please visit your local Audio/Video store and purchase a good quality VHS video head cleaner.
  2. If a video head cleaner does not solve the problem, please consult your dealer or an Authorized Service Center.

### Note

- Remember to read the instructions along with the video head cleaner before use.
- Clean video heads only when problems occur.

### IR signal check

If the remote control does not work properly, you can test if the remote control sends out the infrared signal with a digital camera (including built-in camera of cellular phone). It will help to define the cause of malfunction.

#### With a digital camera (including built-in camera of cellular phone):

Direct a digital camera to remote control, press and hold a button on remote control. If infrared light appears through digital camera, the remote control is working.



## Trademark Information



Kodak and the KODAK Picture CD Compatible logo are trademarks of Kodak used under license.



Manufactured under license from Dolby Laboratories. Dolby and the double-D symbol are trademarks of Dolby Laboratories.

### **Dolby Digital Stereo Creator**

"Dolby® Digital Stereo Creator enables consumers to create stereo DVD-Videos with stunning Dolby Digital sound tracks at home. The technology, when utilized instead of PCM recording, also saves recordable disc space, allowing for higher video resolution or extended recording time on each DVD. DVDs mastered using Dolby Digital Stereo Creator will play back on all DVD-Video players."

**Note:** This is true when the players are compatible with actual recordable DVD discs.



The terms HDMI and HDMI High-Definition Multimedia Interface, and the HDMI Logo are trademarks or registered trademarks of HDMI Licensing LLC in the United States and other countries.

**DVD** is a trademark of DVD Format/Logo Licensing Corporation.

FUNAI is a registered trademark of Funai Electric Co., Ltd. and may not be used in any way without the express written consent of Funai.

© 2013 Funai Electric Co., Ltd.

All rights reserved. No part of this manual may be reproduced, copied, transmitted, disseminated, transcribed, downloaded or stored in any storage medium, in any form or for any purpose without the express prior written consent of Funai. Furthermore, any unauthorized commercial distribution of this manual or any revision hereto is strictly prohibited.

Information in this document is subject to change without notice. Funai reserves the right to change the content herein without the obligation to notify any person or organization of such changes.

*Instructions continue on the next page.*

# CONTENTS

## Introduction

<b>SAFETY INFORMATION</b> .....	<b>2</b>
<b>FEATURES</b> .....	<b>8</b>
Symbols Used in this Owner's Manual .....	9
<b>FUNCTIONAL OVERVIEW</b> .....	<b>10</b>
Front Panel .....	10
Rear Panel .....	11
Remote Control .....	12
Front Panel Display .....	14

## Connections

<b>CONNECTION</b> .....	<b>15</b>
Connecting to an External Tuner .....	15
TV Connection Overview .....	15
Connecting to a TV with an HDMI™ Compatible Port .....	16
Connecting to a TV with Component Video Input jacks .....	17
Connecting to a TV with an S-Video Input Jack .....	17
Connecting to a TV with Audio / Video Input Jacks .....	18
Connecting to a TV without Audio / Video Input Jacks .....	18
Digital Audio Connection .....	19

## Basic Setup

<b>BEFORE YOU START</b> .....	<b>20</b>
Finding the Viewing Channel on Your TV .....	20
Guide to On-Screen Display / Menu .....	21
Main Menu .....	23
Switching DVD / VCR Mode .....	24
How to Insert a Disc / Cassette Tape .....	24
<b>INITIAL SETTING</b> .....	<b>25</b>
<b>SETTING THE CLOCK</b> .....	<b>26</b>

## Recording

<b>INFORMATION ON DVD RECORDING</b> .....	<b>27</b>
<b>BEFORE RECORDING</b> .....	<b>28</b>
Setting for Auto Chapter .....	28
Recording Audio Select (XP) .....	28
Setting Aspect Ratio for Video Mode Recording .....	28
<b>BASIC RECORDING &amp; ONE-TOUCH TIMER RECORDING</b> .....	<b>29</b>
<b>TIMER RECORDING</b> .....	<b>31</b>
Hints for Timer Recording .....	34
<b>SATELLITE LINK</b> .....	<b>35</b>
<b>SETTINGS FOR AN EXTERNAL DEVICE</b> .....	<b>37</b>
Connection to an External Device .....	37
Setting for the Video Input .....	37
Recording from an External Device .....	38
<b>BI-DIRECTIONAL DUBBING</b> .....	<b>39</b>
<b>SETTING A DISC TO PROTECT</b> .....	<b>41</b>
<b>PLAYING THE DISCS ON OTHER DVD PLAYERS</b> ....	<b>42</b>
Finalizing a Disc .....	42
Auto Finalizing .....	43

## Playback

<b>INFORMATION ON PLAYBACK</b> .....	<b>44</b>
<b>BASIC PLAYBACK</b> .....	<b>46</b>
Direct Playback .....	46
Playback from the Title List .....	47
Playing Back an Audio CD and a CD-RW / -R with JPEG Files .....	48
Using the Title / Disc Menu .....	49
Pause .....	49
<b>SPECIAL PLAYBACK</b> .....	<b>50</b>
Resume Playback .....	50
Fast Forward / Fast Reverse Playback .....	50
Skipping TV Commercials During Playback .....	50
Rapid Playback .....	50
Step by Step Playback .....	51
Slow Forward / Slow Reverse Playback .....	51
Zoom .....	51
Marker Setting .....	52
Repeat Playback .....	52
Random Playback .....	53
Slide Show .....	53
Program Playback .....	53
<b>SEARCH</b> .....	<b>54</b>
Title / Chapter Search .....	54
Track Search .....	54
Time Search .....	55
<b>SELECTING THE FORMAT OF AUDIO AND VIDEO</b> ..	<b>56</b>
Switching Subtitles .....	56
Switching Audio Soundtrack .....	56
Switching Camera Angles .....	57
Reducing Block Noise .....	57

## Editing

<b>INFORMATION ON DISC EDITING</b> .....	<b>58</b>
Guide to a Title List .....	58
Editing Discs .....	58
<b>FORMATTING A DISC</b> .....	<b>59</b>
Choosing the Recording Format of a Brand-New DVD-RW .....	59
Reformatting a Disc Manually .....	60
<b>CREATING/DELETING PLAYLIST</b> .....	<b>61</b>
Adding Titles to a Playlist .....	61
Erasing All Playlist .....	62
<b>DELETING TITLES</b> .....	<b>63</b>
<b>EDITING DISCS</b> .....	<b>64</b>
Deleting a Part of a Title .....	64
Putting Names on Titles .....	66
Setting Chapter Marks .....	67
Setting or Clearing All Chapter Marks at Once .....	68
Dividing a Title .....	69
Combining Titles .....	70
Setting or Releasing the Title Protection .....	71

## Function Setup

<b>LIST OF SETTINGS</b> .....	<b>72</b>
<b>SETUPS</b> .....	<b>74</b>
Playback .....	74
Display .....	77
Video .....	78
HDMI .....	79
Reset All .....	80

## VCR Functions

<b>VCR FUNCTIONS</b> .....	<b>81</b>
Information on VCR Functions .....	81
Playback .....	81
Recording .....	81
One-touch Timer Recording (OTR) .....	82
Index Search .....	82
Time Search .....	83
Other Operations .....	83

## Others

<b>TROUBLESHOOTING</b> .....	<b>84</b>
<b>LANGUAGE CODE</b> .....	<b>88</b>
<b>GLOSSARY</b> .....	<b>89</b>
<b>SPECIFICATIONS</b> .....	<b>90</b>

## Español

<b>ESPAÑOL</b> .....	<b>91</b>
----------------------	-----------

## Limited Warranty

<b>Limited Warranty</b> .....	<b>Back Cover</b>
-------------------------------	-------------------

# FEATURES

This unit not only plays back DVD, CD and VCR but also offers features for you to record on DVD and edit them after that. The following features are offered with this unit.

## Recording

This unit is compatible with recording on DVD-RW which is recordable repeatedly and DVD-R which accept the additional recordings until the disc becomes full but not overwriteable.

You can choose either one for your convenience.

Also, this unit allows you to record to the cassette tape.

DVD

VCR

### Up to 12 program recording:

You can program the unit to record up to 12 programs within a one-month period. Daily or weekly program recordings are also available.

### One-touch timer recording (OTR):

You can easily set a recording time as you prefer. Every time [REC] is pressed during recording, the recording time will be increased by 30 minutes up to 8 hours. The recording automatically stops when the recording time you set is reached or the disc is full.

### Dubbing mode:

You can copy a DVD to a cassette tape or copy a cassette tape to a DVD. This function will be possible only if the DVD or a cassette tape is not copy protected.

You cannot record on a cassette tape when its erase-protection tab is removed.

### Left channel stereo recording:

This unit can record the sound of the left channel monaural input as left and right channels automatically.

DVD

### Automatic chapter mark setting:

Chapter marks will be put on recordings as you set before attempting to record.

### Automatic title menu making:

The unit creates title menu automatically when finalizing discs for video mode recording.

### Automatic playlist making:

The unit creates a playlist automatically after recording VR mode DVD-RW.

### Automatic title finalizing:

For video mode DVD-RW/-R recording, you can finalize discs automatically after finishing all timer recordings or at the end of the disc space if you set this in the main menu.

## Playback

DVD

### Theater surround sound in your home:

When connecting the unit to an amplifier or a decoder which is compatible with Dolby Digital, you can experience the theater surround sound from discs with surround sound system.

### Quick search for what you want to watch:

You can easily find the part you want to watch using the search function. Search for a desired point on a disc by title, chapter or time.

### Playing back JPEG / KODAK Picture CD files:

You can enjoy JPEG / KODAK Picture CD files which are recorded on CD-RW/-R.

VCR

### Quick search for what you want to watch:

You can easily find the part you want to watch using the index search/time search functions. An index mark will be assigned at the beginning of each recording you make. For time search function, you can go to a specific point on a cassette tape by entering the exact amount of time you wish to skip.

## Editing

DVD

### Deleting titles:

You can delete titles which you do not need anymore.

### Putting names on titles:

You can put your favorite names on titles.

### Setting / clearing chapter marks:

You can set / clear chapter marks on titles.

### Dividing or combining titles (VR mode DVD-RW only):

You can divide or combine a playlist title.

### Deleting parts of titles (VR mode DVD-RW only):

You can delete a specific part of a title.

## Compatibility

DVD

### Available for playing back discs on a regular DVD player:

Recorded discs can be played back on regular DVD players, including computer DVD drives compatible with DVD-video playback. For DVD-RW/-R, you need to finalize the recorded discs to play back on other DVD players.

## Others

DVD

VCR

### Progressive scan system

Unlike conventional interlace scanning, the progressive scan system provides less flickering and images in higher resolution than that of traditional television signals.

### HDMI (High-Definition Multimedia Interface)









You can enjoy clearer audio/video output when connecting this unit to a display device with an HDMI-compatible port.



## Symbols Used in this Owner's Manual

To specify for what disc type each function is, we put the following symbols at the beginning of each item to operate.

- \* DVD-RW recorded in the non compatible recording format is not recordable.
- \* DVD-R recorded in VR mode is not recordable on this unit.

Symbol	Description
<b>For Recording, Playing Back, and Editing</b>	
	Description refers to DVD-RW (VR mode)
	Description refers to DVD-RW (Video mode)
	Description refers to DVD-R (Video mode)
<b>For Recording and Playing Back</b>	
	Description refers to VHS tapes Use only cassettes marked VHS (  )
<b>For Playback only</b>	
	Description refers to DVD-video
	Description refers to audio CD
	Description refers to CD-RW/-R with JPEG files (KODAK Picture CD files included)

If you do not find any of the symbols listed above under the function heading, the operation is applicable to all media.

# FUNCTIONAL OVERVIEW

## Front Panel

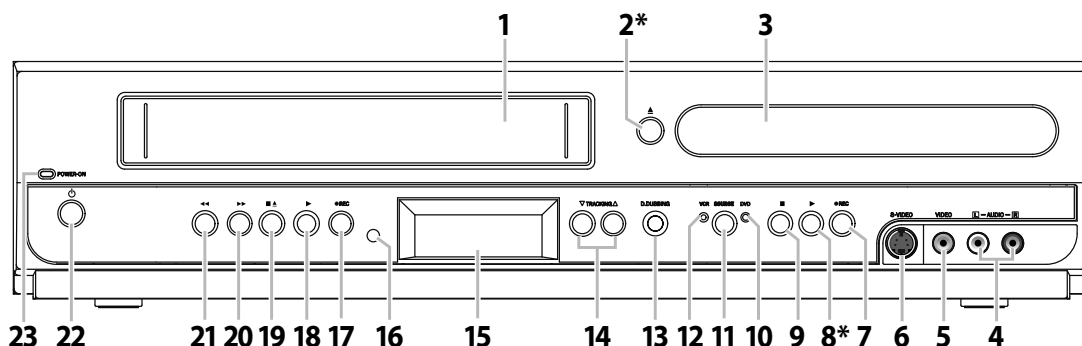

(\*) The unit can also be turned on by pressing these buttons or inserting a cassette tape.

- 1. Cassette compartment (VCR)**  
Insert a cassette tape here.
- 2. ▲ button (DVD)\***  
Press to open or close the disc tray.
- 3. Disc tray (DVD)**  
Place a disc when it is open.
- 4. AUDIO input jacks (L2) (DVD/VCR)**  
Use to connect external device with an RCA audio cable.
- 5. VIDEO input jack (L2) (DVD/VCR)**  
Use to connect external device with an RCA video cable.
- 6. S-VIDEO input jack (L2) (DVD/VCR)**  
Use to connect the S-video output of external device with an S-video cable.
- 7. ● REC button (DVD)**
  - Press once to start a recording.
  - Press repeatedly to start the one-touch timer recording.
- 8. ► button (DVD)\***  
Press to start or resume playback.
- 9. ■ button (DVD)**
  - Press to stop playback or recording.
  - Press to stop the proceeding timer recording in DVD.
- 10. DVD indicator**  
Lights up when the DVD output mode is selected.
- 11. SOURCE button (DVD/VCR)**  
Press to select the component you wish to operate.
- 12. VCR indicator**  
Lights up when the VCR output mode is selected.
- 13. D.DUBBING button (DVD/VCR)**  
Press to start VCR to DVD (DVD to VCR) duplication which you set in the main menu.
- 14. TRACKING ▼ / ▲ buttons (VCR)**
  - Press to adjust the tracking during playback or in slow motion of the cassette tape.
  - While playback is in still mode, you can adjust the picture blurred vertically.
- 15. Display (DVD/VCR)**  
Refer to "Front Panel Display" on page 14.
- 16. Infrared sensor window (DVD/VCR)**  
Receive signals from your remote control so that you can control the unit from a distance.
- 17. ● REC button (VCR)**  
Press once to start a recording. Press repeatedly to start the one-touch timer recording.
- 18. ► button (VCR)**  
Press to start playback.
- 19. ■ ▲ button (VCR)**
  - Press to remove the cassette tape from the cassette compartment.
  - Press to stop cassette tape playback or recording.
  - Press to stop the proceeding timer recording in VCR.
- 20. ►► button (VCR)**  
Press to rapidly advance the cassette tape or view the picture rapidly in forward during playback (forward search).
- 21. ◀◀ button (VCR)**  
Press to rewind the cassette tape or to view the picture rapidly in reverse during playback (rewind search).
- 22. ⏻ button (DVD/VCR)**  
Press to turn On the unit or to turn the unit to the standby mode. (To completely shut down the unit, you must unplug the AC power cord.)
- 23. POWER-ON indicator (DVD/VCR)**  
Red LED lights up when power is on.

## Rear Panel

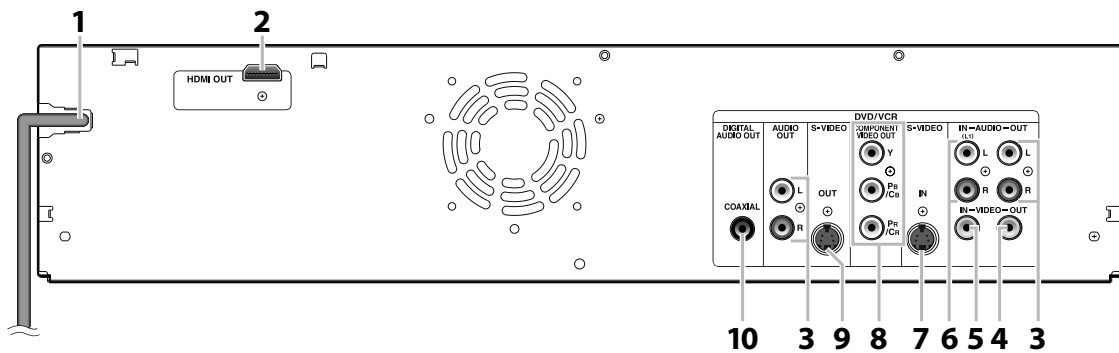

### 1. AC Power Cord

- Connect to a standard AC outlet to supply power to this unit.
- Unplug this cord from the AC outlet to completely shut down the unit.

### 2. HDMI OUT jack

Use an HDMI cable to connect to a display with an HDMI compatible port.

### 3. AUDIO OUT jacks

Use to connect a TV monitor, AV receiver or other device with an RCA audio cable.

### 4. VIDEO OUT jack

Use to connect a TV monitor, AV receiver or other device with an RCA video cable.

### 5. VIDEO IN jack (L1)

Use to connect external device with an RCA video cable.

### 6. AUDIO IN jacks (L1)

Use to connect external device with an RCA audio cable.

### 7. S-VIDEO IN jack (L1)

Use to connect the S-video output of external device with an S-video cable.

### 8. COMPONENT VIDEO OUT jacks

Use to connect a TV monitor with component video inputs with a component video cable.

### 9. S-VIDEO OUT jack

Use to connect the S-video input of a TV monitor, AV receiver or other device with an S-video cable.

### 10. COAXIAL DIGITAL AUDIO OUT jack

Use to connect an AV receiver, Dolby Digital decoder or other device with a digital audio coaxial input jack with a digital audio coaxial cable.

### Note

- Do not touch the inner pins of the jacks on the rear panel. Electrostatic discharge may cause permanent damage to the unit.
- This unit does not have the RF modulator.

### Caution when using S-video, component or HDMI connection for VCR:

- Only the playback video/audio are available with these connections.

# FUNCTIONAL OVERVIEW

## Remote Control

### Installing the Batteries in the Remote Control

Install the batteries (AA 1.5V × 2) matching the polarity indicated inside battery compartment of the remote control.

#### 1 Open the cover.

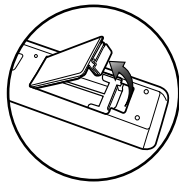

#### 2 Insert batteries.

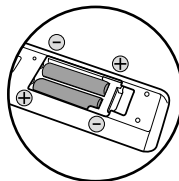

Make sure to match + and - on the batteries to the marks indicated in the battery compartment.

#### 3 Close the cover.

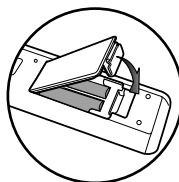

#### Note

Incorrect use of batteries can result in hazards such as leakage and bursting. Please observe the following:

- Lithium or ni-cad and ni-mh rechargeable batteries are not recommended to use for remote control.
- Do not mix different types of batteries such as alkaline and standard (carbon-zinc).
- Do not mix new and old batteries together.
- Do not use different kinds of batteries together. Although they may look similar, different batteries may have different voltages.
- Make sure that the + and - ends of each battery match the indications in the battery compartment.
- Remove batteries from battery compartment that is not going to be used for a month or more.
- When disposing of used batteries, please comply with governmental regulations or environmental public instruction's rules that apply in your country or area.
- Do not recharge, short-circuit, heat, burn or disassemble batteries.



### Using a Remote Control

Keep in mind the following when using the remote control:

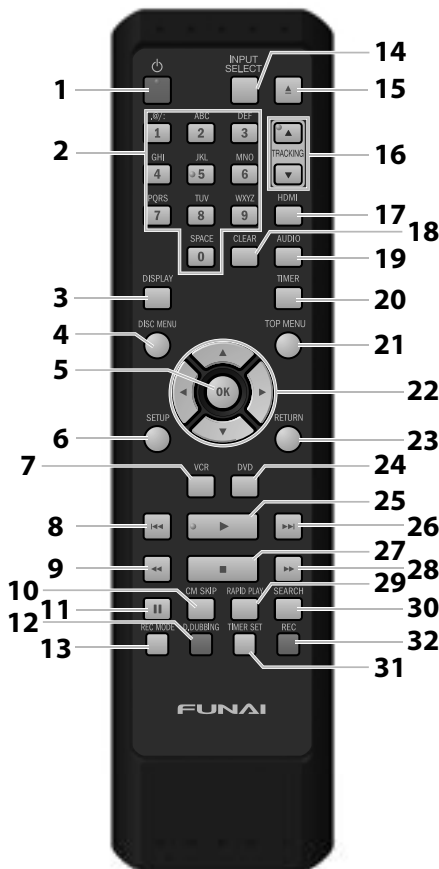
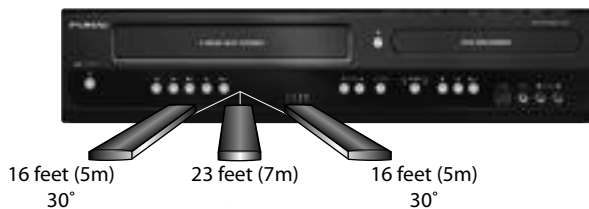
- Make sure that there are no obstacles between the remote control and the infrared sensor window on the unit.
- Remote operation may become unreliable if strong sunlight or fluorescent light is shining on the infrared sensor window of the unit.
- Remote control for different devices can interfere with each other. Avoid using remote control for other device located close to the unit.
- Replace the batteries when you notice a fall off in the operating range of the remote control.
- The maximum operable ranges from the unit are as follows.
  - **Line of sight:** approx. 23 feet (7m)
  - **Either side of the center:** approx. 16 feet (5m) within 30°
  - **Above:** approx. 16 feet (5m) within 15°
  - **Below:** approx. 10 feet (3m) within 30°





Instructions continue on the next page.

- 1.  button (DVD/VCR)**
  - Press to turn On the unit or to turn the unit to the standby mode. (To completely shut down the unit, you must unplug the AC power cord.)
- 2. Number/Character buttons (DVD/VCR)**
  - Press to select a title/chapter/track/file on display.
  - Press to enter values for the settings in the main menu.
  - Press to enter title names.
  - Press to start the index/time search in VCR mode.
- 3. DISPLAY button (DVD/VCR)**
  - Press to display the display menu on or off.
- 4. DISC MENU button (DVD)**
  - Press to display the disc menu.
  - To change original and playlist on the TV screen.
- 5. OK button (DVD/VCR)**
  - Press to confirm or select menu items.
- 6. SETUP button (DVD/VCR)**
  - Press to display the main menu.
  - During DVD playback, press and hold for more than 3 seconds to switch the progressive scanning mode to the interlace mode.
- 7. VCR button**
  - Press to select the VCR output mode.
- 8.  button (DVD)**
  - During playback, press to return to the beginning of the current chapter, track or file.
  - When playback is in pause, press repeatedly to reverse the playback step by step.
  - During playback, press twice in quick succession to skip to the previous chapter or track.
- 9.  button (DVD/VCR)**

**DVD mode:**

  - During playback, press to fast reverse playback.
  - When playback is paused, press to slow reverse playback.



**VCR mode:**

  - During playback, press to rewind the cassette tape or to view the picture rapidly in reverse.
  - Press to fast reverse the cassette tape in stop mode.
- 10. CM SKIP button (DVD)**
  - During playback, press to skip 30 seconds.
- 11.  button (DVD/VCR)**
  - Press to pause playback or recording.
- 12. D.DUBBING button (DVD/VCR)**
  - Press to start VCR to DVD (DVD to VCR) duplication which you set in the main menu.
- 13. REC MODE button (DVD/VCR)**
  - Press repeatedly to switch the recording mode.
- 14. INPUT SELECT button (DVD/VCR)**
  - Press to select the appropriate input.
- 15.  button (DVD/VCR)**

**DVD mode:**

  - Press to open or close the disc tray.

**VCR mode:**

  - Press to remove the cassette tape from the cassette compartment.
- 16. TRACKING  /  buttons (VCR)**
  - Press to adjust the tracking during playback or in slow motion of the cassette tape.
  - While playback is in still mode, you can adjust the picture blurred vertically.
- 17. HDMI button (DVD)**
  - Press to set the HDMI connector's video signal output mode.
- 18. CLEAR button (DVD/VCR)**

**DVD mode:**

  - Press to clear the password once entered or to cancel the programming for CD or to clear the selected marker number, etc.







**VCR mode:**

  - Press to reset the tape counter.
- 19. AUDIO button (DVD/VCR)**

**DVD mode:**

  - Press to display the audio menu during playback.

**VCR mode:**

  - During playback of a Hi-Fi videotape, press to change the audio out setting.
- 20. TIMER button (DVD/VCR)**
  - Press to display the timer programming list.
- 21. TOP MENU button (DVD)**
  - Press to display the title list.
- 22. Cursor  /  /  /  buttons (DVD/VCR)**
  - Press to select items or settings.
- 23. RETURN button (DVD/VCR)**
  - Press to return to the previously displayed menu screen.
- 24. DVD button**
  - Press to select the DVD output mode.
- 25.  button (DVD/VCR)**
  - Press to start playback or resume playback.
- 26.  button (DVD)**
  - During playback, press to skip to the next chapter, track or file.
  - When playback is in pause, press repeatedly to forward the playback step by step.
- 27.  button (DVD/VCR)**
  - Press to stop playback or recording.

**DVD mode:**

  - Press to exit from the title list.
- 28.  button (DVD/VCR)**



**DVD mode:**

  - During playback, press to fast forward playback.
  - When playback is paused, press to slow forward playback.

**VCR mode:**

  - During playback, press to rapidly advance the cassette tape or view the picture rapidly in forward.
  - When playback is paused, press to view the cassette tape in slow motion.
  - Press to fast forward the cassette tape in stop mode.
- 29. RAPID PLAY button (DVD)**
  - During playback, press to play back in a slightly faster/slower mode with keeping the audio quality.
- 30. SEARCH button (VCR)**
  - Press to call up the index or time search menu.
- 31. TIMER SET button (DVD/VCR)**
  - Press to set the unit in the timer standby mode. In the timer standby mode, press to cancel the mode and to turn the unit on.
- 32. REC button (DVD/VCR)**
  - Press once to start a recording.
  - Press repeatedly to start the one-touch timer recording.

## Note

- If you turn this unit to the standby mode, [>] on the remote control is not available. Be sure to use [>] or [ >] on the unit.

# FUNCTIONAL OVERVIEW

## Front Panel Display

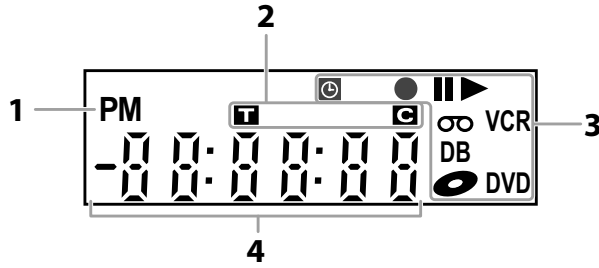

### 1.

**PM** : Appears in the afternoon with the clock display.

### 2. Title / track / file and chapter mark

**T** : Appears when indicating a title / track / file number.

**C** : Appears when indicating a chapter number.

### 3. Current status of the unit

**||** : Appears when playback is in pause or in step by step playback.

**▶** : Appears when playing back a disc or a cassette tape.

**||▶** : Appears during slow forward / reverse playback.

**⏰** : Appears when the timer programming or OTR has been set or is proceeding.  
: Flashes when all timer recordings have been finished.

**●** : Appears during recording process.  
: Flashes when a recording is in pause.

**Ⓛ** : Appears when this unit is in DVD output mode and a disc is in the unit.  
: Appears during duplication process.

**∞** : Appears when this unit is in VCR output mode and a cassette tape is in the unit.  
: Appears during duplication process.

**VCR** : Appears when this unit is in VCR output mode.  
: Appears when the timer recording is proceeding in VCR.  
: Appears when VCR is in the timer recording standby mode.  
: Flashes when a program cannot be performed for some reason.

**DVD** : Appears when this unit is in DVD output mode.

: Appears when the timer recording is proceeding in DVD.

: Appears when DVD is in the timer recording standby mode.

: Flashes when a program cannot be performed for some reason.

**DB** : Appears during VCR to DVD duplication process.

: Appears during DVD to VCR duplication process.

### 4. Displays the following

- Elapsed playback time
- Current title / chapter / track / file number
- Recording time / remaining time
- Clock
- Selected external input position
- Remaining time for one-touch timer recording
- Selected HDMI output mode
- VCR tape counter

## Display Message



Appears when the disc tray is opening.



Appears when HDMI output mode (480p) is selected.

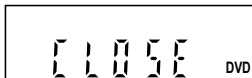

Appears when the disc tray is closing.

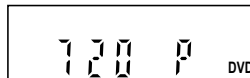

Appears when HDMI output mode (720p) is selected.

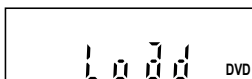

Appears when a disc is loaded on the disc tray.



Appears when HDMI output mode (1080i) is selected.

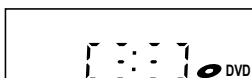

Appears when data is being recorded on a disc.



Appears when HDMI output mode (1080p) is selected.

# CONNECTION

## Read this first:

- 1) Disconnect the AC power cords of the devices from the AC outlet.
- 2) Make the connection as illustrated below.
- 3) After making all the connections, connect the AC power cords of the devices.

- Connect this unit directly to the TV. If the RCA audio/video cables are connected to a VCR, pictures may be distorted due to the copy protection system.

## Connecting to an External Tuner

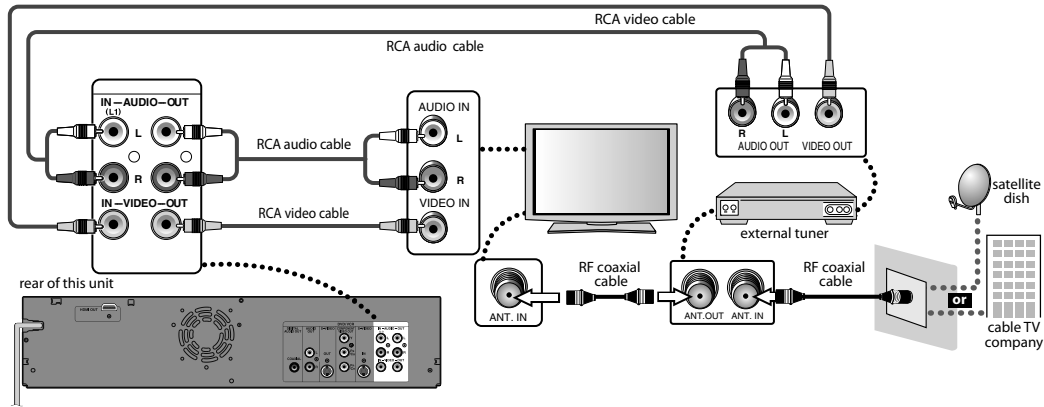

### Note

- Required cables and connecting methods differ depending on the external tuner. For more information, please contact your external tuner provider.

### With this setup:

- You can record any unscrambled channel by selecting the channel on the external tuner. When using the external tuner connect the unscrambled cable signal to the external tuner and then send the output cable signal from the unit to the Cable Box. Be sure that the external tuner is turned on.
- **You cannot record one channel while watching another channel.**

### Supplied cables used in this connection are as follows:

- RCA audio cable (L/R) x 1
  - RCA video cable x 1
- Please purchase the rest of the necessary cables at your local store.



## TV Connection Overview

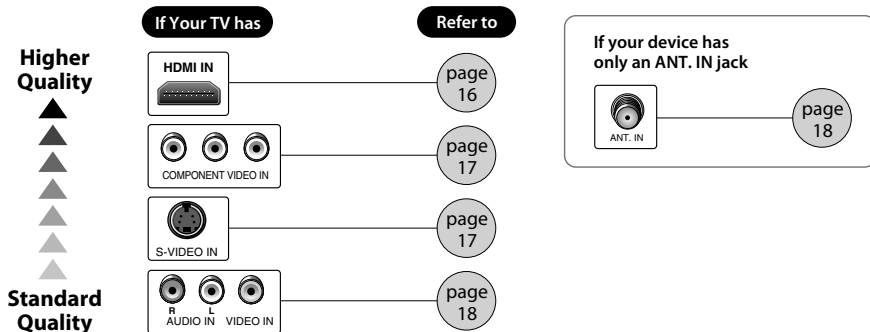

# CONNECTION

## Connecting to a TV with an HDMI™ Compatible Port

- HDMI outputs the video / audio signals without converting to analog signals.
- No audio connection is required.

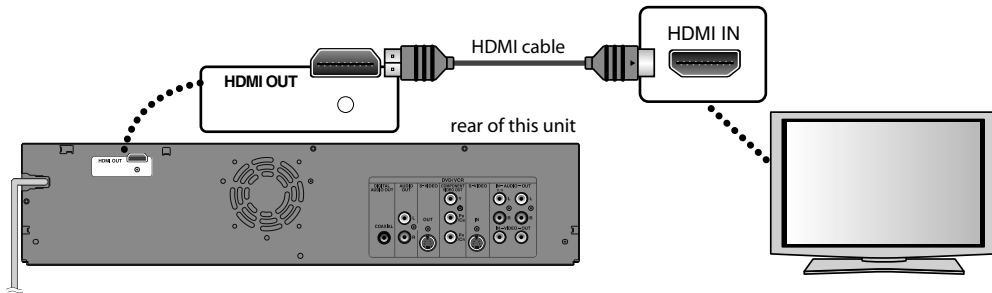

Do not tilt the connector when inserting it into the HDMI jack, and make sure the shapes of the jack and the connector are matched.

### Cables not included.

Please purchase the necessary cables at your local store.

### HDMI Mode and Actual Output Signals

Press [HDMI] to select the HDMI output mode. The output mode changes as follows every time [HDMI] is pressed.

Front Panel Display	Video Output Signal
480P	480 Progressive
Press [HDMI]	↓
720P	720 Progressive
Press [HDMI]	↓
1080i	1080 interlaced
Press [HDMI]	↓
1080P	1080 Progressive
Press [HDMI]	

- The HDMI mode that is not supported by display device will be skipped.

### Copyright protection system

To play back the digital video images of a DVD via an HDMI connection, it is necessary that both the player and the display device (or an AV amplifier) support a copyright protection system called HDCP (high-bandwidth digital content protection system). HDCP is copy protection technology that comprises data encryption and authentication of the connected AV device. This unit supports HDCP. Please read the operating instructions of your display device (or AV amplifier) for more information.

### Note for HDMI Connection

- Because HDMI is an evolving technology, it is possible that some devices with an HDMI input may not operate properly with this unit.
- When using an HDCP-incompatible display device, the image will not be viewed properly.
- Among the devices that support HDMI, some devices can control other devices via the HDMI connector; however, this unit cannot be controlled by another device via the HDMI connector.
- When this unit's HDMI connector is connected to a DVI-D compatible monitor (HDCP compatible) with an HDMI-DVI converter cable, the signals are output in digital RGB.
- When the power failure occurs or when you unplug the unit, some problems in the HDMI setting might occur. Please check and set the HDMI setting again.



## Connecting to a TV with Component Video Input jacks

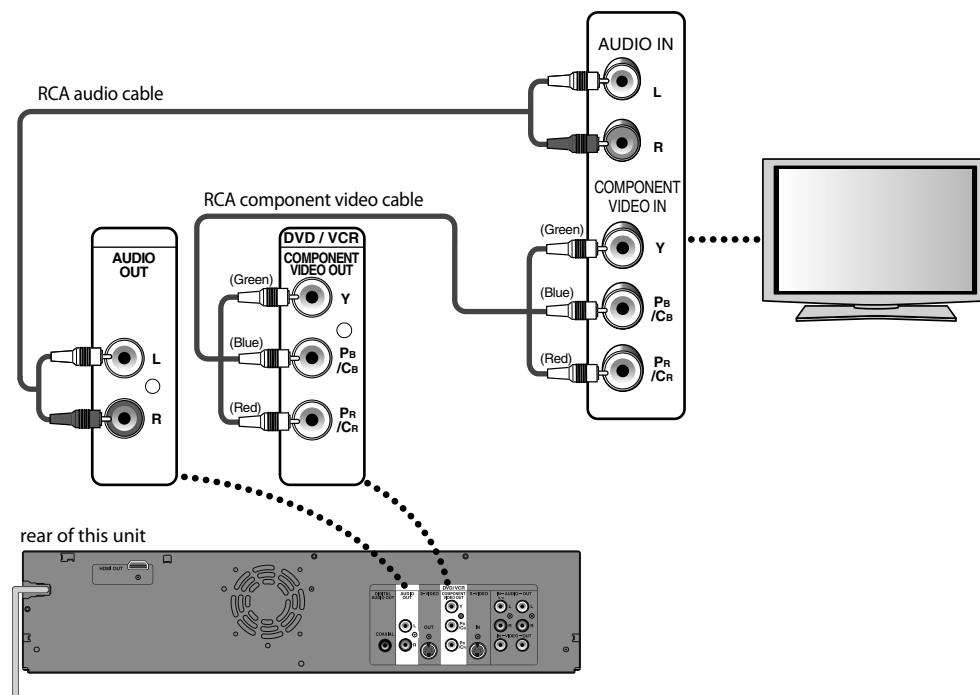

### Supplied cables used in this connection are as follows:

- RCA audio cable (L/R) x 1
- Please purchase the rest of the necessary cables at your local store.

## Connecting to a TV with an S-Video Input Jack

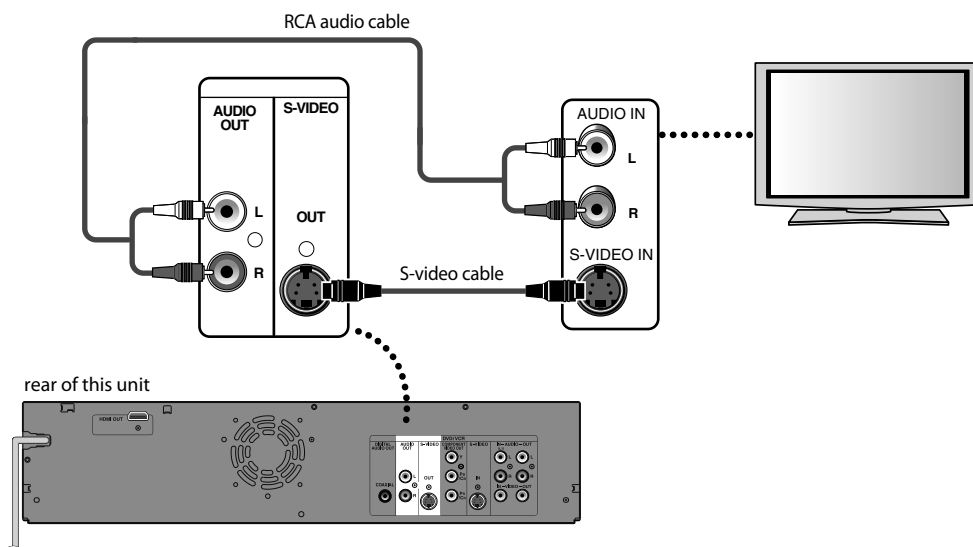

### Supplied cables used in this connection are as follows:

- RCA audio cable (L/R) x 1
- Please purchase the rest of the necessary cables at your local store.

# CONNECTION

## Connecting to a TV with Audio / Video Input Jacks

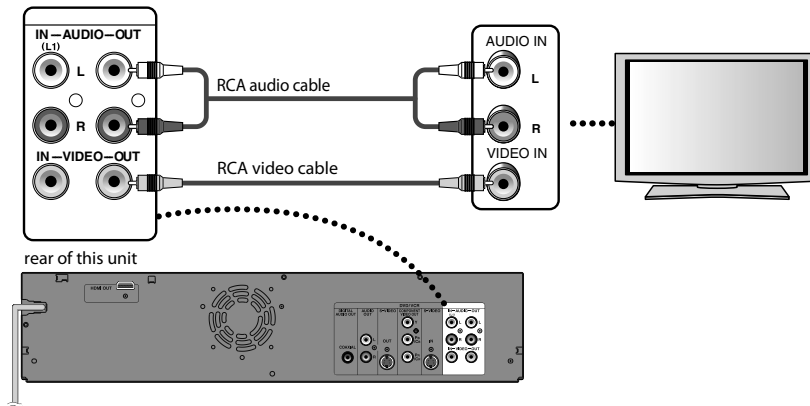

### Supplied cables used in this connection are as follows:

- RCA audio cable (L/R) x 1
  - RCA video cable x 1
- Please purchase the rest of the necessary cables at your local store.

## Connecting to a TV without Audio / Video Input Jacks

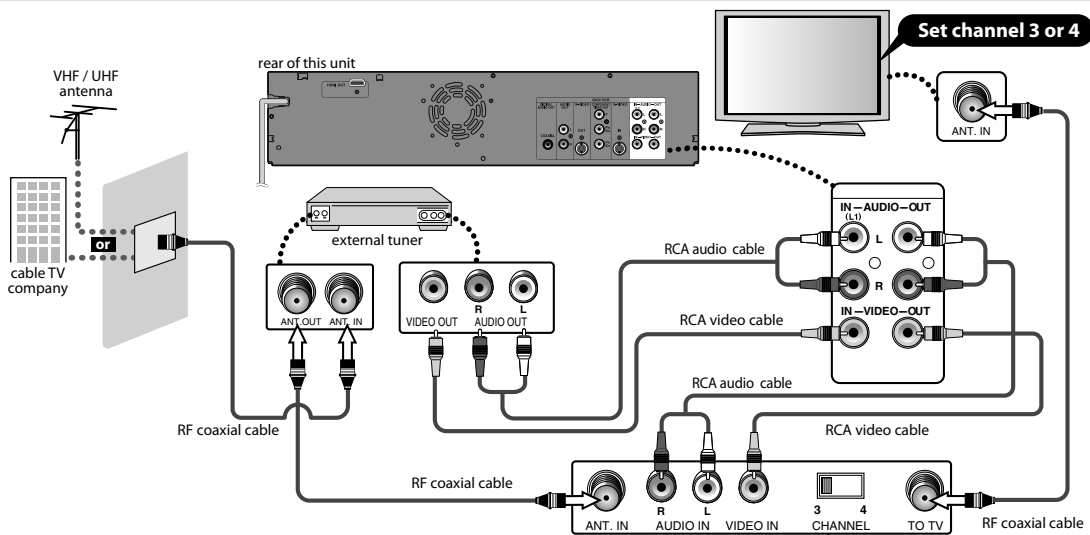

### No Antenna (RF) Output!

If your TV only has an Antenna input (no A/V inputs), you will need a RF modulator (NOT INCLUDED) to connect this player.



### Supplied cables used in this connection are as follows:

- RCA audio cable (L/R) x 1
  - RCA video cable x 1
- Please purchase the rest of the necessary cables at your local store.

### Note

- RF modulator is not supplied with this unit. You need to purchase it at your local store.
- The quality of picture may become poor if this unit is connected to an RF modulator.

## Digital Audio Connection

### Coaxial Cable Connection

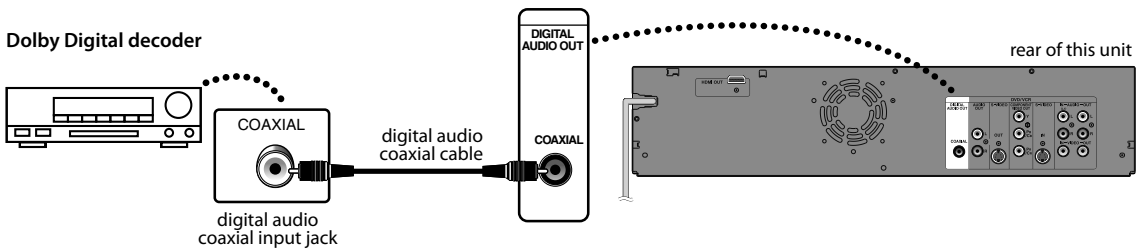

### HDMI Audio Connection

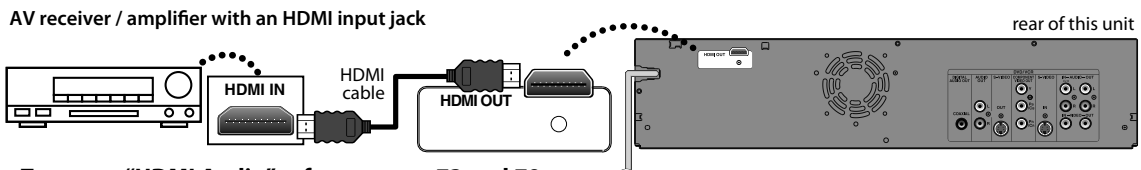

To set up "HDMI Audio" refer to pages 73 and 79.

To set up "Dolby Digital" refer to pages 72 and 76.

Audio format (disc)	Dolby Digital Setting of this unit	HDMI	Digital Output
Dolby Digital	PCM	2channel PCM	2channel PCM
	Stream	Dolby Digital	Dolby Digital
LPCM	PCM	2channel PCM	—
	Stream		

↑  
Actual Output

### Cables not included.

Please purchase the necessary cables at your local store.

### Note

- The audio source on a disc in a Dolby Digital multi channel surround format cannot be recorded as digital sound by an MD or DAT deck.
- By connecting this unit to a Dolby Digital decoder, you can enjoy high-quality Dolby Digital multi channel surround sound as movie theaters.
- Playing back a DVD using incorrect settings may generate noise distortion and may also damage the speakers.

## 2 Channel Analog Audio Connection

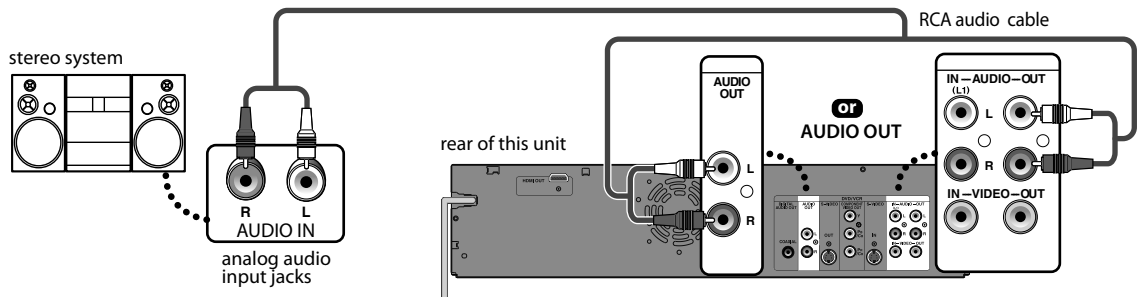

### Supplied cables used in this connection are as follows:

- RCA audio cable (L/R) x 1

# BEFORE YOU START

After you have completed all the connections, you must find the viewing channel (external input channel) on your TV.

## Finding the Viewing Channel on Your TV

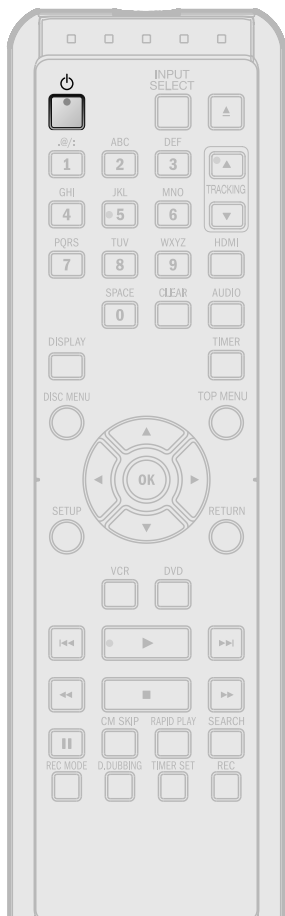

**1** After you have made all the necessary connections, press [  ] to turn on the unit.

**2** Turn on your TV.  
 • If connected to your VCR make sure it is switched off or in standby mode before proceeding.

**3** Press “2” on the TV’s remote control, then press channel down button repeatedly until you see “Initial Setup” menu.

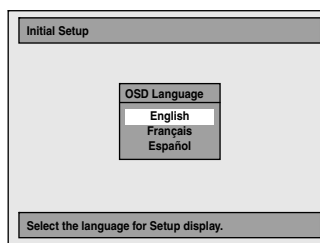

This is the correct viewing channel (external input channel) for the recorder.

- For some TVs, there may be a button on the TV’s remote control that accesses the external input channel. It may be labeled “SOURCE”, “AV” or “SELECT”. In such case, press it repeatedly. Refer to your TV’s user manual for details.
- If more than 10 minutes have passed since you have turned on the unit, you may see the Funai screen saver instead of “Initial Setup” menu.

Funai screen saver:

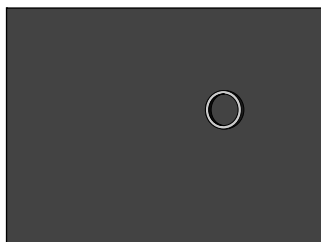

**4** Proceed to step 2 in “INITIAL SETTING” on page 25.

### Input Mode Names for Common TV Brands (Example)

Admiral	AUX	Panasonic	TV/VIDEO
Curtis Mathis	LINE1, LINE2, 00, 90, 91, 92, 93	RCA	INPUT, TV/VCR, 00, 90, 91, 92, 93
GE	INPUT, TV/VCR, 00, 90, 91, 92, 93	Samsung	TV/VIDEO
Hitachi	INPUT, AUX	Sanyo	VIDEO
JVC	VIDEO, VIDEO 1, VIDEO 2, VIDEO 3	Sharp	00
Kenwood	AUX	Sony	VIDEO1, VIDEO2, VIDEO3
LXI-Series	00	Toshiba	TV/GAME
Funai	AUX CHANNEL	Zenith	00

### Note

- Video input selection varies for different brand’s models of TVs.
- Consult your TV manufacturer if none of the above are successful.

# BEFORE YOU START

This unit uses the following on-screen displays and menus to guide you to the easy operations. The on-screen displays give you the information on the loaded disc or the disc/file in playback or the HDMI status, etc. The menus allow you to change the various kinds of settings for playing back, recording or editing to suit your preference.

## Guide to On-Screen Display / Menu

The on-screen display changes in the following order as you press [DISPLAY].

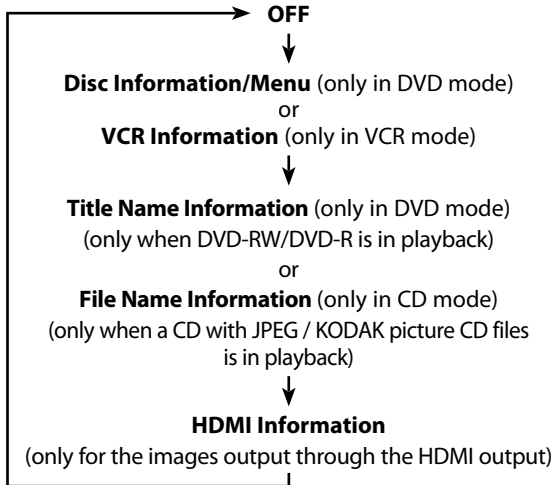

## Disc Information / Menu

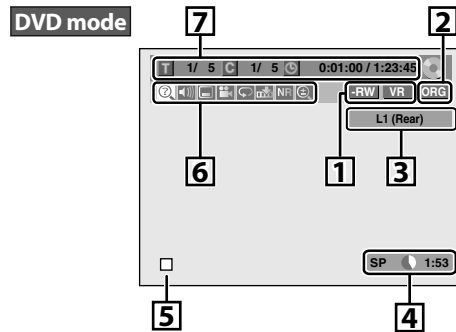

\* This is an example screen only for explanation. Displayed items vary depending on the disc you inserted.

1. Indicates a disc type and format mode.
2. Indicates a type of titles for VR mode DVD-RW .
3. Indicates the selected external input channel.
4. Indicates a recording mode and possible recording time left.
5. Indicates an operation status.
6. Each icon means:

- : Search
- : Audio
- : Subtitle
- : Angle
- : Repeat
- : Marker
- : Noise Reduction
- : Zoom

7. Indicates the current title number/total number of titles, the current chapter number/total number of chapters, and time lapse of the current title playback/ total duration of the title.

# BEFORE YOU START

## VCR Information

VCR mode

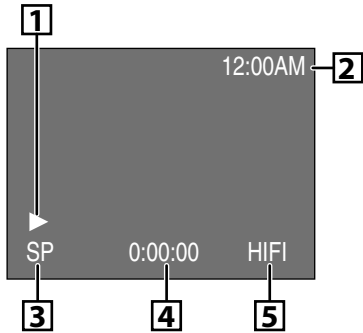

\* This is an example screen only for explanation.  
Displayed items vary depending on the cassette tape  
you inserted.

\* During stop mode or pause, VCR information is not  
available with HDMI connection.

1. Indicates current video status.
2. Indicates the current time.
3. Indicates a recording or playing back mode.
4. Indicates a tape counter.
5. Audio status of the current cassette tape.

### Note

- VCR information does not appear on the screen when  
the unit is connected by an HDMI, component or  
S-video cable, except during the playback.

## HDMI Information

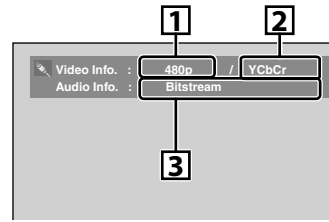

1. Indicates the resolution of the HDMI output image.
  2. Indicates the HDMI video format.
  3. Indicates the HDMI audio format.
- "--" will be displayed, when it does not have any  
information.

## Title/File Name Information

Title Name Information

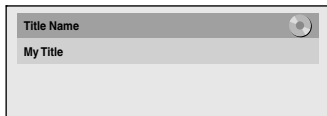

File Name Information

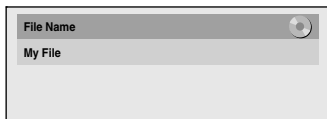

## Main Menu

Press **[SETUP]** to display the main menu. Then use **[▲ / ▼]** to select a menu and press **[OK]** to display the menu. These menus provide entries to all main functions of the unit.

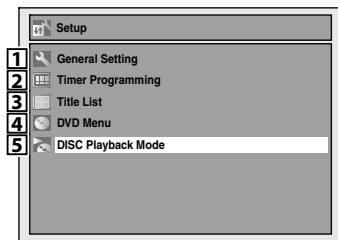

- 1. General Setting:**  
To go to general setting menu.
- 2. Timer Programming:**  
To program a timer recording.
- 3. Title List:**  
To call up the title list.
- 4. DVD Menu:**  
To set up the DVD setting.
- 5. DISC Playback Mode:**  
To set up the disc playback setting.
  - "DISC Playback Mode" is available only when an audio CD, a CD-RW/-R with JPEG / KODAK picture CD files is inserted into the unit.

## General Setting Menu

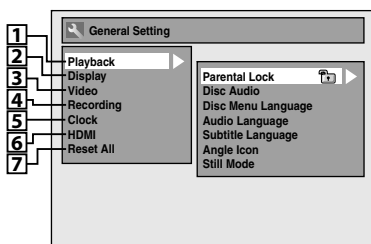

- 1. Playback:**  
To set up the unit to play back discs as you prefer.
- 2. Display:**  
To set up the OSD screen as you prefer.
- 3. Video:**  
To set up the video setting.
- 4. Recording:**  
To set up the unit to record to discs as you prefer.
- 5. Clock:**  
To set up the clock of the unit as you need.
- 6. HDMI:**  
To set up the HDMI connection setting.
- 7. Reset All:**  
To reset the setting to the factory default.

## DVD Menu / DISC Playback Mode

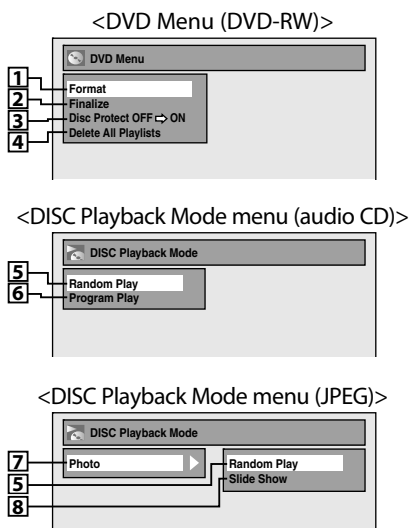

- 1. Format:** (DVD-RW only)  
Allows you to format the disc.
- 2. Finalize:**  
Allows you to finalize a disc containing recorded titles.
- 3. Disc Protect :** (VR mode DVD-RW only)  
Allows you to protect a disc from accidental editing or recording.
- 4. Delete All Playlists:** (VR mode DVD-RW only)
- 5. Random Play:**  
Allows you to activate the random playback feature.
- 6. Program Play:** (audio CD only)  
Allows you to activate the program playback feature.
- 7. Photo :**  
Allows you to make setting for JPEG playback.
- 8. Slide Show:** (JPEG / KODAK Picture CD files only)  
Allows you to select the display time of the slide show mode.

# BEFORE YOU START

## Switching DVD / VCR Mode

Because this product is a combination of a VCR and a DVD recorder, you must select first which component you wish to operate.

### DVD mode

Press **[SOURCE]** on the front panel or press **[DVD]** on the remote control.  
(Verify that the DVD indicator is lit.)

### VCR mode

Press **[SOURCE]** on the front panel or press **[VCR]** on the remote control.  
(Verify that the VCR indicator is lit.)

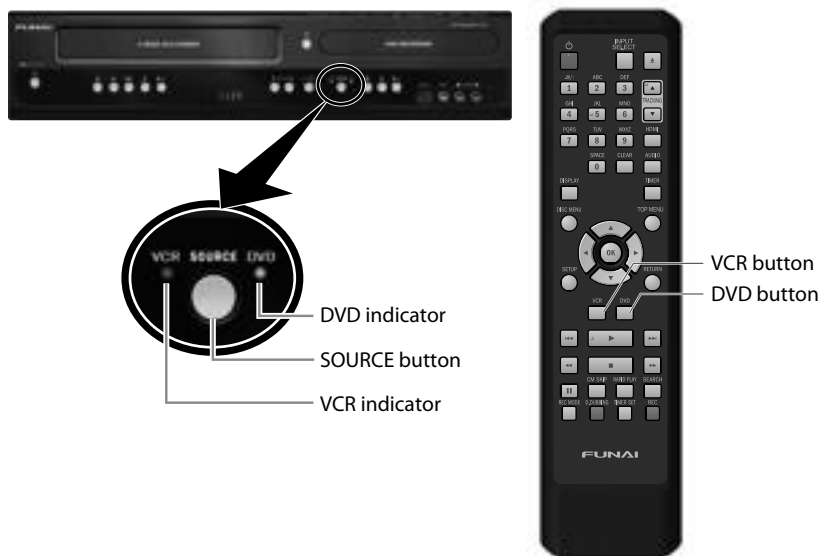

### Note

- You cannot switch to another mode while in the timer-standby mode.
- Playback will stop when you change the output mode.

## How to Insert a Disc / Cassette Tape

### How to Insert a Disc

- 1) Press **[DVD]**.
- 2) Press **[▲]** to open the disc tray.
- 3) Place the disc on the disc tray with its label side facing up.

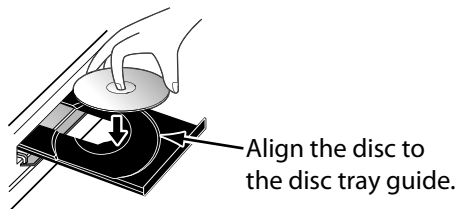

- 4) Press **[▲]** to close the disc tray.

It may take a while to load the disc.

### To eject the disc:

Press **[▲]** to open the disc tray, then remove the disc before turning the unit to the standby mode.

### How to Insert a Cassette Tape

- 1) Press **[VCR]**.
- 2) Insert a cassette tape as illustrated below.

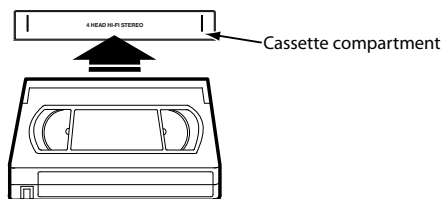

- Insert from the flap side first with the window side facing up.

### To eject the cassette tape:

Press **[■ ▲]** on the front panel or press **[▲]** on the remote control.

### Note

- If you turn this unit to the standby mode, **[▲]** on the remote control is not available. Be sure to use **[▲]** or **[■ ▲]** on the unit.



# INITIAL SETTING

You need to follow these steps when you turn on this unit for the first time.



**1** Follow the procedure in “Finding the Viewing Channel on Your TV” on page 20 to display “Initial Setup” menu.

**2** Use [▲ / ▼] to select your desired language, then press [OK].

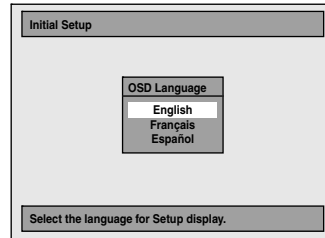

**3** Proceed to step 4 in “SETTING THE CLOCK” on page 26.

# SETTING THE CLOCK

Set the clock before you try the timer programming. Follow these steps below.

**1** Press [SETUP] and use [▲ / ▼] to select "General Setting", then press [OK].

"General Setting" menu will appear.

**2** Use [▲ / ▼] to select "Clock", then press [OK].

"Clock Setting" menu will appear.

**3** Use [▲ / ▼] to select calendar or time, then press [OK].

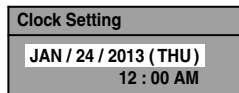

**4** Use [◀ / ▶] to select an item to set, and use [▲ / ▼] to select the contents to suit your preference, then press [OK] when you finish setting all the contents.

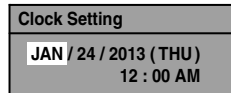

Your setting will be activated.

The clock start counting when you press [OK].

**5** Press [SETUP] to exit.

## Note



- Your setting will be cancelled if you press [SETUP] before pressing [OK] at step 4.
- Your clock setting will be lost if either there is a power failure or this unit has been unplugged for more than 30 seconds when you set the clock manually.
- For setting the day, year, hour, and minute, [the Number buttons] can also be used.
- You can set the built-in calendar from the year 2012 up to 2062.

# INFORMATION ON DVD RECORDING

Before you make a recording, read the following information.

## Recordable Discs

This unit can record to DVD-RW and DVD-R. DVD-R can only be recorded to once. DVD-RW can be recorded to and erased many times.

Logos	Attributes
 DVD-RW	8cm/12cm, single-sided, single layer disc Approx. max. recording time (SLP mode): 360 minutes (4.7GB) (for 12cm) 108 minutes (1.4GB) (for 8cm)
 DVD-R	

- Following discs are recommended for good recording quality and are proven to be compatible with this unit. However, depending on the media condition the unit may not read the disc properly.

Verbatim	DVD-R 8x,	DVD-RW 2x
JVC	DVD-RW 4x	
Maxell	DVD-R 8x/16x	

Performance of any other discs are not guaranteed.

## Unrecordable Discs

- DVD-RW recorded in the non compatible recording format is not recordable.
- DVD-R recorded in VR mode is not recordable on this unit.
- DVD+RW/+R is not recordable on this unit.

## Recording Mode

You can select a recording mode among 5 options, and the recording time will depend on the recording mode you select as follows.

Disc size	Recording mode	Recording time	Video/sound quality
8cm Disc	XP (1Hr)	18 min	☆☆☆☆☆ (good)
	SP (2Hr)	36 min	☆☆☆☆
	LP (4Hr)	72 min	☆☆☆
	EP (6Hr)	108 min	☆☆ (poor)
	SLP (8Hr)	144 min	☆
12cm Disc	XP (1Hr)	60 min	☆☆☆☆☆ (good)
	SP (2Hr)	120 min	☆☆☆☆
	LP (4Hr)	240 min	☆☆☆
	EP (6Hr)	360 min	☆☆
	SLP (8Hr)	480 min	☆ (poor)

- The recording time is only an estimate. The actual recording time may differ.
- The audio and video quality gets poorer as the recording time becomes longer.
- Each time [REC MODE] is pressed, recording mode and its allowed recording time will be displayed.

## Note

- **This unit cannot record to CD-RW or CD-R.**
- All high definition pictures will be down converted to the standard definition pictures when they are recorded on this unit.
- DVD-RW/-R and CD-RW/-R recorded on a personal computer or a DVD or CD recorder may not be played back if the disc is damaged or dirty or if there is condensation on the player's lens.
- If you record a disc using a personal computer, even if it is recorded in a compatible format it may not be played back because of the settings of the application software used to create the disc. (Check with the software publisher for more detailed information.)
- Since the recording is made by the VBR (variable bit rate) method, depending on the picture you are recording, the actual remaining time for recording may be a little shorter than the remaining time displayed on the TV screen.

## Restrictions on Recording

You cannot record copy-protected program using this unit. Copy-protected video signal is included in DVD-videos, some satellite broadcasts, some pay-per-view stations and some "premium" stations.

If copy-protected material is detected, recording will pause or stop automatically and an error message appears on the screen.

"Copy-once only" video can only be recorded to CPRM compatible DVD-RW formatted in VR mode.

### What is "CPRM"?

CPRM is a copy protection system with scramble system regarding the recording of "copy-once" broadcast programs. CPRM stands for Content Protection for Recordable Media.

This unit is CPRM compatible, which means that you can record copy-once broadcast programs, but you cannot make another copy of those recordings. CPRM recordings can only be made on CPRM compatible DVD-RW formatted in VR mode, and CPRM recordings can only be played back on DVD players that are specifically compatible with CPRM.

### Making discs playable in other DVD players (Finalize)

For DVD-RW/-R, it is necessary to finalize the disc after recording, in order to play back the disc on other DVD players. (Refer to pages 42 - 43.)

When video mode disc are finalized, a title menu is created. You cannot finalize discs in other DVD recorders

# BEFORE RECORDING

## Setting for Auto Chapter



You can set a specified time for chapter marks.

- 1) Press [SETUP] and use [▲ / ▼] to select "General Setting", then press [OK].  
"General Setting" menu will appear.
- 2) Use [▲ / ▼] to select "Recording", then press [OK].  
"Recording" menu will appear.
- 3) Use [▲ / ▼] to select "Auto Chapter", then press [OK].
- 4) Use [▲ / ▼] to select a desired time option, then press [OK].

Auto Chapter	
<input type="checkbox"/>	OFF
<input type="checkbox"/>	5 minutes
<input checked="" type="checkbox"/>	10 minutes
<input type="checkbox"/>	15 minutes
<input type="checkbox"/>	30 minutes
<input type="checkbox"/>	60 minutes

- 5) Press [SETUP] to exit.

### Note

- The interval for auto chapter may be up to two minutes different from the time option you set.
- A blank chapter may be created depending on the remaining time of the disc.

## Recording Audio Select (XP)



You can enjoy high quality sound recording. This function works only when the recording mode is set at XP.

- 1) Press [SETUP] and use [▲ / ▼] to select "General Setting", then press [OK].
- 2) Use [▲ / ▼] to select "Recording", then press [OK].  
"Recording" menu will appear.
- 3) Use [▲ / ▼] to select "Recording Audio Select (XP)", then press [OK].
- 4) Use [▲ / ▼] to select "PCM" or "Dolby Digital", then press [OK].

Recording Audio Select (XP)	
<input type="checkbox"/>	PCM
<input checked="" type="checkbox"/>	Dolby Digital

### PCM:

Records PCM audio for the best quality sound.

### Dolby Digital:

Records Dolby Digital audio for good quality sound.

- 5) Press [SETUP] to exit.

### Note

"PCM" stands for Pulse Code Modulation. It changes analog sound to digital sound without compressing audio data.

When the recording mode is set at other than XP, the unit records "Dolby Digital" audio automatically even if you selected "PCM".

## Setting Aspect Ratio for Video Mode Recording



You can set aspect ratio for video mode recording.

- 1) Follow step 1 to 2 on "Recording Audio Select(XP)".
- 2) Use [▲ / ▼] to select "Aspect Ratio (Video mode)", then press [OK].
- 3) Use [▲ / ▼] to select your desired setting, then press [OK].

Aspect Ratio (Video mode)	
<input checked="" type="checkbox"/>	Auto
<input type="checkbox"/>	4 : 3
<input type="checkbox"/>	16 : 9

**Auto (default):** It will be recorded with whichever the ratio that the program you started to record are broadcasted with.

**4:3 :** Recorded in the aspect ratio of 4:3.

**16:9 :** Recorded in the aspect ratio of 16:9.

- 4) Press [SETUP] to exit.

### Note

For DVD-RW VR mode, the image will be recorded in whichever the ratio that the program you record are broadcasted with, regardless of the "Aspect Ratio (Video mode)" setting.

# BASIC RECORDING & ONE-TOUCH TIMER RECORDING



Follow the steps to record TV programs from an external tuner.

This unit has no tuner system so it cannot receive TV broadcasts without an external tuner or such devices.



# 1

**Press [DVD] first.**

**Insert a recordable disc (refer to page 24 on how to insert a disc).**

\* Make sure the disc is compatible with this unit. (Refer to page 27 for the list of compatible discs.)

**It may take a while to load the disc.**

- When inserting a brand-new DVD-RW, the unit automatically starts to format.

# 2

**Press [REC MODE] repeatedly to select a recording mode.**

Refer to "Recording Mode" on page 27.



# 3

**Press [INPUT SELECT] to select the appropriate external input position (L1/L2) to which your external tuner is connected. Then select the desired channel to record on the external tuner.**

## 4 Press [REC] to start recording.

"●" will be displayed for 4 seconds.

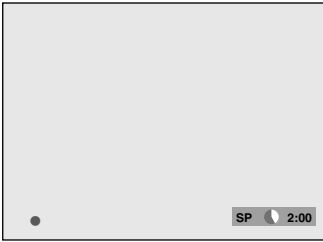

Press [II] to pause recording.  
Press [II] or [REC] again to restart recording.

## 5 Press [■] to stop recording.

The recorded title will appear in the title list.  
(Refer to "Guide to a Title List" on page 58.)

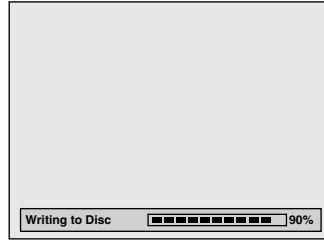

• This operation may take awhile to be completed.

### To set one-touch timer recording (OTR)...

This is a simple way to set the recording time in blocks of 30 minutes.

Press [REC] repeatedly until the desired recording time (30 minutes to 8 hours) appears on the TV screen.

One-touch timer recording will start.

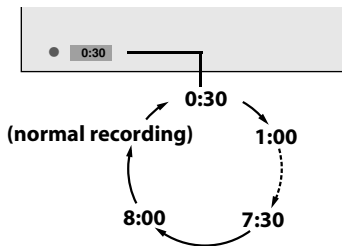

### To change the recording length during the one-touch timer recording:

Press [REC] repeatedly until the desired length appears.

### To cancel the one-touch timer recording within the specified time:

Press [■].

### Note

- When you press [REC], recording starts immediately and continues until the disc is full or you stop recording.
- When the unit clock has not been set, the space for a date and time of title names will be blank.
- You cannot change the recording mode during the recording pause mode.
- You can change a channel (external input) to be recorded during the recording pause mode.

### Note for one-touch timer recording

- The remaining recording time will be displayed on the front panel display during one-touch timer recording. Press [DISPLAY] to see it on the TV screen.
- Unlike the timer recording, you can perform the following operations during one-touch timer recording.
  - Turning the power to standby to stop one-touch timer recording.
  - Using [REC] or [■] on the remote control.
- You cannot use the pause function during one-touch timer recording.
- If DVD one-touch timer recording is completed during VCR playback or recording, the DVD will be in stop mode and the VCR keeps the current mode.
- When one-touch timer recording is finished and the power is turned to standby, the unit will switch to the timer-standby mode automatically if a timer recording has been programmed. Press [TIMER SET] to cancel the timer-standby mode to use the unit continuously.

# TIMER RECORDING



You can program the unit to record up to 12 programs within a month in advance. Daily or weekly program recordings are also available.

## Before recording, make sure

- Set the clock before setting a timer programming.
- Insert a recordable disc with enough recordable space or a cassette tape with an erase-protection tab.



## Guide to Timer Programming Display

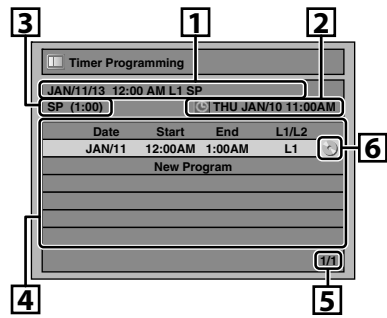

- 1 Title of a timer program (Contains date, time, selected external input position, recording mode of the program)
- 2 Current date and time
- 3 Recording mode, and length of the recording
- 4 Timer program list
- 5 Total number of pages and current page (2 pages maximum)
- 6 Recording media (“” (DVD) or “” (VCR))

**1** Press [TIMER].

**2** Use [▲ / ▼] to select “New Program”, then press [OK].

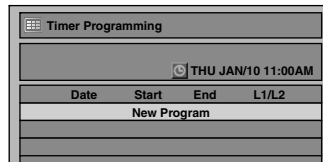

- If there are 6 or more programs, use [◀ / ▶] to change pages.

**3** Use [▲ / ▼] to enter the date, then press [▶].

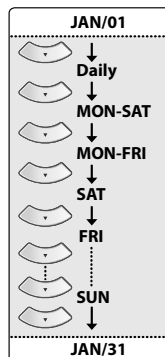
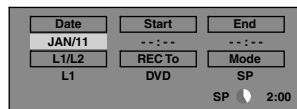

When pressing [▼] at the current date, the date will change as follows.  
e.g.) January 1st

## Note

- **If you have not set the clock yet:**  
Entry screen for the clock setting will appear instead of the timer programming list at step 1. Continue with the step 4 in “SETTING THE CLOCK” on page 26 before setting a timer programming.
- Use [◀ / ▶] to move the cursor to the left and the right in the entry screen for the timer programming.
- If a basic recording or one-touch timer recording is in progress on one component (e.g., VCR) and the timer recording set for the other component (e.g., DVD) is about to begin, the unit automatically switches to the programmed channel for timer recording 2 minutes before the programmed starting time, and the recording in progress (for VCR) will be cancelled UNLESS their recording channels are the same. If their recording channels are the same, the timer recording will start without canceling the recording currently in progress. In this case, the recording of the same channel will be made on both DVD and VCR.
- You cannot make a program whose recording time exceeds 12 hours.
- Cancel the timer-standby mode by pressing [TIMER SET] before operation for either DVD or VCR. When finished operating, press [TIMER SET] to resume the timer-standby mode.
- In the timer-standby mode, you can turn on the power and use the component (VCR or DVD) which is not currently timer-programmed.

**4** Use [▲ / ▼ / ◀ / ▶] or [the Number buttons] to enter the start and end time, then press [▶].



- You cannot make a program which recording time exceeds 12 hours.

**5** Use [▲ / ▼] to select the appropriate external input position (L1 / L2) to which your external tuner is connected, then press [▶].

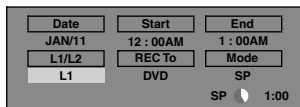

**6** Use [▲ / ▼] to select the recording media ("DVD" or "VCR"), then press [▶].

e.g.) recording to DVD

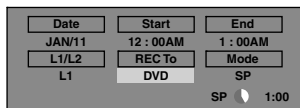

**7** Use [▲ / ▼] to select a recording mode.



Refer to "Recording Mode" on page 27.

- When recording to DVD, you can check the remaining recordable space of the disc when you select the recording mode.



### Auto recording mode select (DVD only)...

When "Auto" is selected as a recording mode, the unit calculates how much time is available on the disc and selects the best recording mode available automatically to complete recording the program.

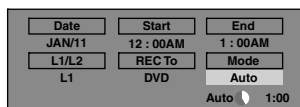

- "Auto" is only available for one program in the timer program list.
- The recording may be cut short when the available recording space of the disc is too limited.

**8** Press [OK] when all items are entered. After displaying an instructive message for 10 seconds, timer program list will appear.

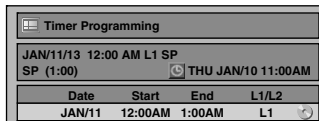
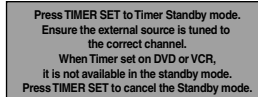

Your program setting is now stored.

- To set another program, repeat steps 2 to 8.
- To exit, press [TIMER] or [SETUP].
- When 2 or more programs are overlapped, "Timer program overlapped" appears, and the overlapped program will be displayed in blue.
- To correct the timer program refer to "Checking, canceling or correcting the timer programming information" on page 33.

**9** Press [TIMER SET] to set a timer programming.

⌚ will appear on the front panel display, while this unit waits to make the recording.



"VCR" will appear on the front panel display if VCR timer recording have been set.



# TIMER RECORDING

## To stop the timer recording in progress

- 1) Press [■] on the remote control.
- 2) Confirmation message will appear. Select "Yes", then press [OK].
  - To stop the timer recording immediately, press [■] on the unit.

## Checking, canceling or correcting the timer programming information

- 1) Press [TIMER SET].
- 2) Press [TIMER].
- 3) Check the information.

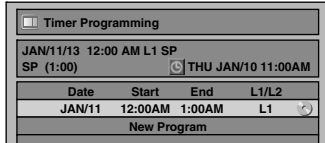

### 4-A) To delete the timer program:

- 1 Use [▲ / ▼] to select the program you want to delete, then press [OK].
- 2 Use [▲ / ▼] to select "Delete", then press [OK]. Confirmation window will appear.
- 3 Use [▲ / ▼] to select "Yes", then press [OK].

### 4-B) To correct the timer program:

- 1 Use [▲ / ▼] to select the program you want to correct, then press [OK].
- 2 Use [▲ / ▼] to select "Program Change", then press [OK].
- 3 Correct the timer program by using [▲ / ▼ / ◀ / ▶], then press [OK].

### 5) Press [TIMER] to exit.

### 6) Press [TIMER SET] to return to the timer standby mode.

### Note

- Press [TIMER] to check the timer recording in progress. When the timer recording is proceeding, that program will be highlighted with red. In this case, you cannot select any other program.

If the timer program did not complete correctly, the error number appears in the timer programming list.

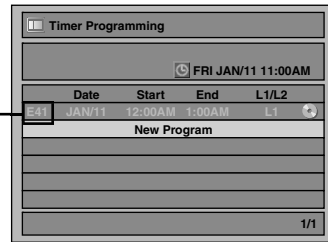



### Each error number means:

E1-22	Recording error other than below
E37-39	
E23-24	Unrecordable disc
E25-28	Copy prohibited program
E29	Disc protected
E30	Disc full
E31-32	Already 99 titles recorded
E33	Already 999 chapters recorded
E34	No space for Control information
E35	PCA full *1
E36	Already finalized video format disc
E40	Some portion has not been recorded because of program overlapping. Recording did not start at the start time.
E41	Power failed
E42	No disc when recording

- A program with the error number is grayed in the timer programming list.
- Timer program with an error number will be cleared once the entry screen for the program is displayed.
- \*1 PCA is a disc's space reserved for recording test.

# TIMER RECORDING

## Hints for Timer Recording

- If there is a power failure or this unit has been unplugged for more than 30 seconds, the clock setting and all timer programming will be lost.
- If a disc is not inserted, "DVD" on the front panel display flashes and timer recording cannot be performed. In some cases,  will appear momentarily around the start time as the unit attempts to record. Please insert a recordable disc.
- If a cassette tape with an erase-protection tab is not in the cassette compartment or there is no cassette tape in the cassette compartment, "VCR" on the front panel display flashes and timer recording cannot be performed. Please insert a recordable cassette tape.
- If a cassette tape ends during the timer recording, the unit will automatically stop, eject the cassette tape, and turn itself to the standby mode. To continue recording, insert a recordable tape.
- When all the timer recordings are completed,  flashes. Press **[TIMER SET]** to release the unit from the timer standby mode.
- If both DVD and VCR are timer programmed, you cannot use any functions for either unit during timer standby or timer recording. If you want to use functions other than recording under such condition, cancel timer recording by pressing **[TIMER SET]** during timer standby or stop recording by pressing **[■]** / **[■ ▲]** on the front panel of the unit during timer recording.
- To cancel the timer standby mode, press **[TIMER SET]**.
- When the starting and the ending time are the same, "Exceeds 12 hours" appears and the program setting will not be accepted.
- When the disc or cassette tape becomes full during the recording, the unit turns itself to the standby mode.
- If the starting time is earlier and the ending time is later than the current time, the recording will start right after you press **[TIMER SET]** at step 9 on page 32.
- The timer recording cannot be performed in DVD and VCR at the same time. If you set 2 programmings with the same channel and time in both devices, the program which is set first will have the priority.
- "Press TIMER SET for timer recording" will appear on the TV screen 5 minutes before the programmed starting time.

## The Priority of Overlapped Settings

- Timer program which has the earlier start time will be placed first in the timer program list, and be given priority over the programs with the later start time when timer programs overlap.
- When timer programs overlap, the first 2 minutes (at the longest) of the later recording will be cut off.
- When 2 or more timer programs have the same start time, the program set first will be given priority.
- A timer recording of lower priority will be cancelled or start from the middle.
- Check the overlapped timer programmings and change the priority if necessary.

### ■ When the starting time is the same:

A program set previously (PROG. A) has priority.

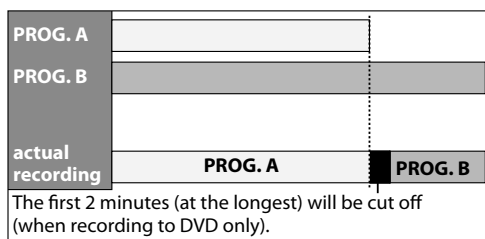

## Note for DVD recording

- When the recording time of 2 programs are overlapped or the end time of a program and the start time of another program is the same, the first 2 minutes (at the longest) of the subsequent program will be cut off.
- If the cut-off portion comes up to 3 minute or more, this program will be displayed with error number E40 in the timer programming list.

### ■ When the end time of the programming currently being recorded and the start time of the subsequent program are same:

The beginning of the PROG. B may be cut off.

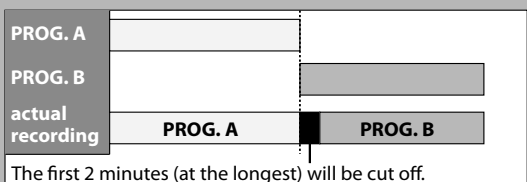

# SATELLITE LINK



You can set the unit to start recording whenever it detects the video signal from the external tuner.

## Preparing for the satellite link timer recording: Preparation on the tuner

- Satellite link accepts only the connection from L1 (rear) with the external tuner. (The connection from L2 cannot read any signals from the external tuner.)
- The external tuner should be equipped with some kind of timer function. Using timer function of the tuner, set it to output audio/video signals when it comes to the time you want to start recording, and stop output audio/video signals when it comes to the time you want to finish recording. Refer to the tuner's manual on how to set the timer.
- Make sure to set the satellite link standby mode when you finish setting.



**1** Press [SETUP].

**2** Use [▲ / ▼] to select "Timer Programming", then press [OK].

**3** Use [▲ / ▼] to select "Satellite Link", then press [OK].

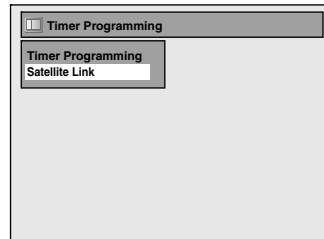

**4** Use [▲ / ▼] to select the time, media and recording mode, then press [OK].

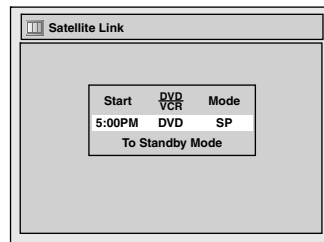

**5** Use [▲ / ▼] to set the desired starting time, then press [▶].

- The hour can be selected from 1 to 12 with AM or PM.
- Repeat procedures in step 5 to set the desired minutes.
- If you wish to go back to the left, press [◀].

**6** Use [▲ / ▼] to select a recording media ("DVD" or "VCR"), then press [▶].

**7** Use [▲ / ▼] to select the recording mode.  
Refer to page 27 for details.

Instructions continue on the next page.

**8** Press [OK].  
 "To Standby Mode" is highlighted.

**9** Press [OK] again.

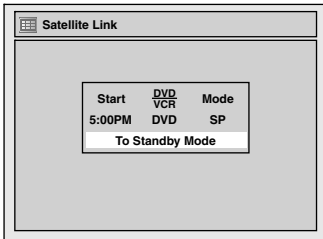

In a second, the unit will be turned off automatically as it goes into the satellite link standby mode.

**To cancel the satellite link function while in the satellite link standby mode:**

Press [TIMER SET] to turn on the unit.

**To cancel the satellite link function while the satellite link recording is in progress:**

Press [■] on the front panel to stop the disc recording.

Press [■ ▲] on the front panel to stop the cassette tape recording.

**Notes**

- If the signal of external input breaks up over 5 seconds, satellite link function will be cancelled.
- If you have not set the clock, "Clock Setting" menu will appear at step 4. Follow to step 4 in "SETTING THE CLOCK" on page 26.
- You cannot set the ending time for the satellite link timer recording on this unit.
- Recording picture will be distorted if the copy protection signal is being detected during satellite link timer recording.
- You can record the satellite link by using S-video input jacks on the rear panel. Refer to page 17 for more information.
- When a regular timer recording and the satellite link timer recording are overlapped, those recordings are recorded as illustrated below.
- Press [TIMER] during the satellite link timer recording to check the satellite link timer recording in progress.

	example 1	example 2	example 3
timer recording			
satellite link			
actual recording			

The first 2 minutes (at the longest) will be cut off.

The first 2 minutes (at the longest) will be cut off.

# SETTINGS FOR AN EXTERNAL DEVICE

## Connection to an External Device

Connect the external device properly to the unit by using input jacks either L2 (Front) or L1 (Rear). When connecting an external device of monaural output to this unit, use AUDIO L jack of L2 (Front) or L1 (Rear). Use S-video or the RCA audio/video cables for this connection.

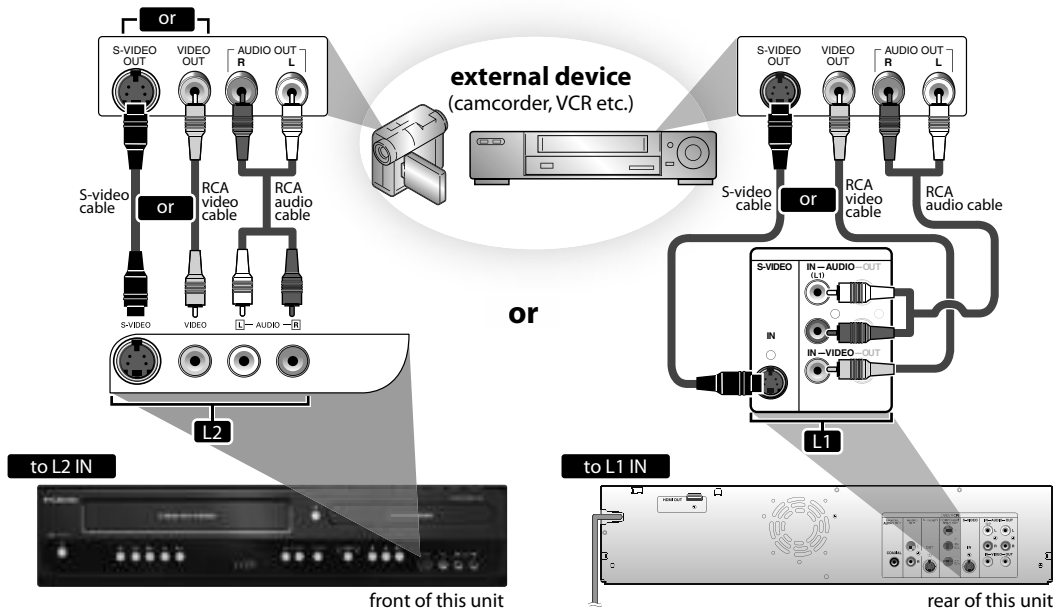

### Supplied cables used in this connection are as follows:

- RCA audio cable (L/R) x 1
  - RCA video cable x 1
- Please purchase the rest of the necessary cables at your local store.

## Setting for the Video Input



**1** Press [SETUP] and use [▲ / ▼] to select "General Setting", then press [OK].

"General Setting" menu will appear.

**2** Use [▲ / ▼] to select "Video", then press [OK].

Submenu will appear.

**3** Use [▲ / ▼] to select "Select Video", then press [OK].

**4** Use [▲ / ▼] to select desired external input, then press [OK].

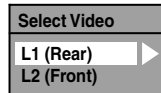

**5** Use [▲ / ▼] to select the input jack type to connect, then press [OK].  
If you want to use VIDEO IN jack, select "Video In".  
If you want to use S-VIDEO IN jack, select "S-Video In".

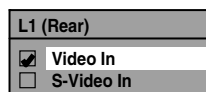

**6** Press [SETUP] to exit.

# SETTINGS FOR AN EXTERNAL DEVICE

## Recording from an External Device



Before recording from an external device, refer to the instructions for the connection on page 37.

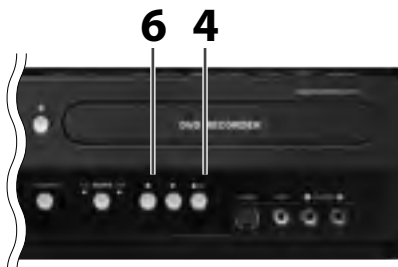
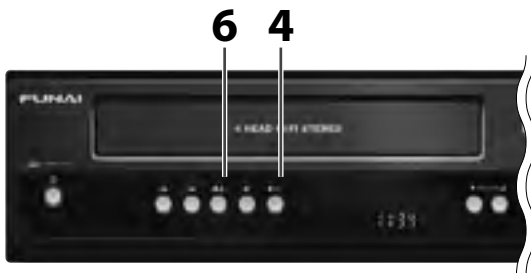

# 1

### Recording to a DVD

Press [DVD].

Insert a recordable disc (refer to page 24 on how to insert a disc).

It takes a while to load the disc.

### Recording to a Cassette Tape

Press [VCR].

Insert the cassette tape with an erase-protection tab intact.

# 2

Select the appropriate external input channel (L1 or L2) by pressing [INPUT SELECT].

- If the external device is connected to the rear of this unit, select L1.
- If the external device is connected to the front of this unit, select L2.
- You can also select L1 or L2 channel by using [the Number buttons].  
e.g.) For L1, press [0], [0], [1].

# 3

Press [REC MODE] repeatedly to select a recording mode.

Refer to "Recording Mode" on page 27 for DVD or "Recording" on page 81 for VCR.

# 4

Press [●REC] on the unit to start recording.

# 5

Start playback on the external device to record from.

# 6

For disc:

Press [■] on the unit to stop recording.

For cassette tape:

Press [■▲] on the unit to stop recording.

This operation may take a while to be completed.

# BI-DIRECTIONAL DUBBING



You can copy contents in a DVD to a cassette tape or do vice versa. This function is available only when the contents are not copy-protected. (Before you start, refer to page 27 for the list of compatible discs.)



## Preparing for dubbing (cassette tape to DVD):

- Insert a cassette tape to be dubbed.
- Insert a recordable DVD.
- Make sure there is enough space on the DVD.

## Preparing for dubbing (DVD to cassette tape):

- Insert a disc to be dubbed.
- Insert a cassette tape with an erase-protection tab in tact.
- Make sure there is enough recordable length on the tape.

**1** Press [SETUP] and use [▲ / ▼] to select "General Setting", then press [OK].

"General Setting" menu will appear.

**2** Use [▲ / ▼] to select "Recording", then press [OK].

"Recording" menu will appear.

**3** Use [▲ / ▼] to select "Dubbing Mode", then press [OK].

Selection menu will appear.

### Note for dubbing

- Dubbing direction setting in "Dubbing Mode" menu is always reset to "VCR → DVD" whenever you turn the power to the standby mode.
- You cannot change the output mode during VCR to DVD or DVD to VCR duplication.

### Note for recording to a tape:

Make sure

- the cassette tape's erase-protection tab is intact.
- the cassette tape is long enough.

### Note for recording to a disc:

Make sure

- the disc is compatible (refer to page 27).

Instructions continue on the next page.

# BI-DIRECTIONAL DUBBING

## VCR to DVD

**4** Use [ $\blacktriangle$  /  $\blacktriangledown$ ] to select "VCR  $\rightarrow$  DVD", then press [OK].

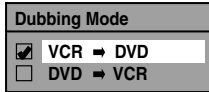

Press [SETUP] to exit.

**5** Press [DVD], then press [REC MODE] repeatedly to select the desired recording mode.

**6** Press [VCR], then press [ $\blacktriangleright$ ] to find the point where you wish to start dubbing.

**7** Press [II] when you come to the desired start point.

**8** Press [D.DUBBING].  
VCR to DVD duplication will start.

**9** Press [■] to stop the dubbing.

## DVD to VCR

**4** Use [ $\blacktriangle$  /  $\blacktriangledown$ ] to select "DVD  $\rightarrow$  VCR", then press [OK].

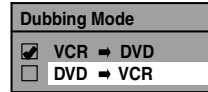

Press [SETUP] to exit.

**5** Press [VCR], then press [REC MODE] repeatedly to select the desired recording mode.

Rewind or fast forward the tape to the point where you want to start recording.

**6** Press [DVD], then press [ $\blacktriangleright$ ] to find the point where you wish to start dubbing.

**7** Press [II] when you come to the desired start point.

**8** Press [D.DUBBING].  
DVD to VCR duplication will start.

**9** Press [■] to stop the dubbing.

### **Note for DVD to VCR duplication**

- This function is available for audio CD, but not with JPEG / KODAK Picture CD files.
- The recording mode for VCR cannot be displayed at step 5 when using HDMI / Component / S-Video connection. To display the VCR recording mode on the screen, the unit must be connected by the VIDEO OUT jack and the TV's input select should be set to the appropriate external input channel.

### **Note for VCR to DVD duplication**

- After starting VCR to DVD duplication, the picture may be distorted because of the auto tracking function. This is not a malfunction. Be advised to play back the tape until the picture is stabilized, then set the starting point which you wish to start recording, and start VCR to DVD duplication.
- This unit will automatically stop the duplication if playback with no image is detected for more than 3 minutes during VCR to DVD duplication.
- Playback sound mode of the dubbed contents is determined by the playback sound mode of the VCR at the point of dubbing.



# SETTING A DISC TO PROTECT



To prevent accidental recording, editing or erasing the titles, you can protect them from "DVD Menu".



**1** Press [SETUP].

**2** Use [▲ / ▼] to select "DVD Menu", then press [OK].

**3** Use [▲ / ▼] to select "Disc Protect OFF → ON", then press [OK].

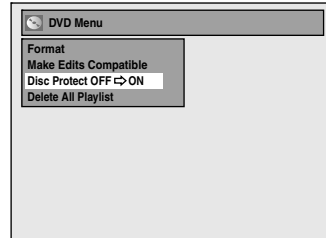

**4** Use [▲ / ▼] to select "Yes", then press [OK].

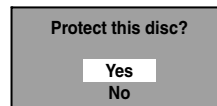

A disc will be protected.

**This operation may take a while to be completed.**

## Note

### To cancel the disc protect:

- When you insert a disc protected with this unit, "Disc Protect ON → OFF" will appear instead of "OFF → ON" at step 3.

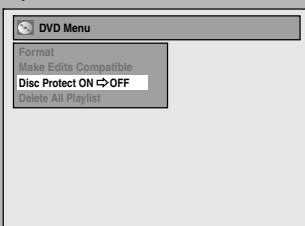

To release the protection for the disc, select "Disc Protect ON → OFF" at step 3, then follow rest of the procedures.

# PLAYING THE DISCS ON OTHER DVD PLAYERS

## Finalizing a Disc



You will need to finalize DVD-RW or DVD-R to play them back on other DVD players.

Finalizing may take several minutes up to an hour.

A shorter recording period on the disc will require a longer time period for finalization. Do not unplug the power cord during finalization.



**1** Press [SETUP].

**2** Use [▲ / ▼] to select "DVD Menu", then press [OK].  
"DVD Menu" menu will appear.

**3** Use [▲ / ▼] to select "Finalize", then press [OK].

**4** Use [▲ / ▼] to select "Yes", then press [OK].

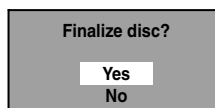



Finalizing will start.

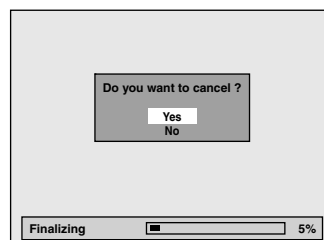

### To cancel finalizing... (DVD-RW only)

- To cancel finalizing at step 4, press [■], select "Yes" with [▲ / ▼], then press [OK]. Finalizing is cancelled and the unit will be in stop mode.



- If  appears when pressing [■], you cannot cancel finalizing because the finalizing has been in progress.
- When selecting "No" and press [OK] or [RETURN], finalizing will be continued.
- You cannot cancel finalizing the DVD-R once it has started.

**This operation may take a while to be completed.**

### Note

- Once you have finalized a DVD-R, you cannot edit or record anything on that disc.
- Even if you have finalized a DVD-RW recorded in VR mode, you can edit, record or delete a title.
- When you insert a DVD-RW finalized with this unit, "Undo Finalize" will appear instead of "Finalize".



To release the finalizing for the disc, select "Undo Finalize" at step 3.

\* DO NOT turn the power off or to the standby mode during finalization, this will result in malfunction.

**5** Finalizing is completed.

# PLAYING THE DISCS ON OTHER DVD PLAYERS

## Auto Finalizing



You can finalize discs automatically using this function. You can use this function to finalize discs after finishing timer recordings and at the end of the disc space.



**1** Press [SETUP] and use [▲ / ▼] to select “General Setting”, then press [OK].

“General Setting” menu will appear.

**2** Use [▲ / ▼] to select “Recording”, then press [OK].

“Recording” menu will appear.

**3** Use [▲ / ▼] to select “Auto Finalize”, then press [OK].

**4** Use [▲ / ▼] to select “Disc Full” or “End of Timer Rec”, then press [OK].

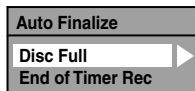

**5** Use [▲ / ▼] to select “ON”, then press [OK].  
e.g.) “Disc Full”

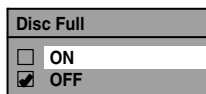

Your setting will be activated.

**6** Press [SETUP] to exit.

### Note







- This function is not available after finishing daily or weekly program recording.

# INFORMATION ON PLAYBACK

Before you play back DVD, read the following information.

## Playable Discs and Files

This unit is compatible to play back the following discs. To play back a DVD, make sure that it meets the requirements for region codes and color systems as described below. You can play back discs that have the following logos will play back on the unit. Other disc types are not guaranteed to play back.

Playable discs	Logos
DVD-video	
DVD-RW (VR or Video mode)	
DVD-R (Video mode)	
CD-DA (audio CD)	
CD-RW	
CD-R	
KODAK Picture CD	
Playable files	Media
JPEG	CD-RW/-R

 is a trademark of DVD Format/Logo Licensing Corporation.

## Unplayable Discs

The following discs will not play back on this unit.

- CD-ROM
- DVD-RAM
- DVD-ROM
- Unfinalized disc
- DVD or CD contains Windows Media™ Audio/DivX®/MP3 files
- Blu-ray Disc™
- Super Video CD
- Compact Disc-Interactive (CD-I)
- Video Single Disc (VSD)
- DVD-audio
- Video CD (VCD)
- HD DVD

On the following disc, the sound may not be heard.

- Super audio CD - Only the sound on the CD layer can be heard. The sound on the high-density super audio CD layer cannot be heard.

## Color Systems

DVD is recorded in different color systems throughout the world. The most common color system is NTSC (which is used primarily in the United States and Canada). This unit uses NTSC, so DVD you play back must be recorded in the NTSC system. You cannot play back DVD recorded in other color systems.

## Region Codes

This unit has been designed to play back DVD with region 1. DVD must be labeled for ALL regions or for region 1 in order to play back on the unit. You cannot play back DVD that are labeled for other regions. Look for the symbols on the right on your DVD. If these region symbols do not appear on your DVD, you cannot play back the DVD in this unit.



The number inside the globe refers to region of the world.

A DVD labeled for a specific region can only play back on the unit with the same region code.

*Instructions continue on the next page.*

## Hint for DVD Playback

The contents of DVD are generally divided into titles.  
Titles may be further subdivided into chapters.

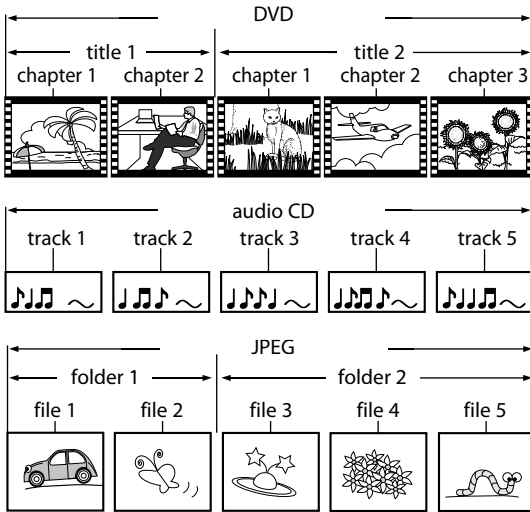

# BASIC PLAYBACK

## Direct Playback



1

**Press [DVD] first.**  
**Insert a playable disc (refer to page 24 on how to insert a disc).**

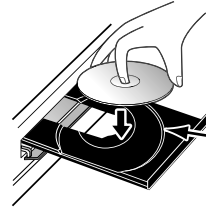

Align the disc to the disc tray guide.

\* Make sure the disc is compatible with this unit.  
(Refer to page 44 for the list of compatible discs.)

**It may take a while to load the disc.**

2

**Press [▶] to start playback.**

If you are playing back a DVD-video, a menu may appear.  
Refer to "Using the Title / Disc Menu" on page 49.

3

**Press [■] once to stop playback temporarily.**

• Refer to "Resume Playback" on page 50.

### Note

- Some discs may start playback automatically.
- Playback will stop when you change the output mode.

## Playback from the Title List



### 1 Press [DVD] first. Insert a playable disc (refer to page 24 on how to insert a disc).

\* Make sure the disc is compatible with this unit. (Refer to page 44 for the list of compatible discs.)

**It may take a while to load the disc.**

- To exit the title list, press [■].
- To resume the title list, press [TOP MENU].

### 2 Press [TOP MENU]. Title list will appear. Press [DISC MENU] to switch Original/Playlist if necessary.

- To exit the title list, press [■].
- To resume the title list, press [TOP MENU].

### 3 Use [▲ / ▼ / ◀ / ▶] to select a desired title, then press [OK].

e.g.) VR mode DVD-RW original

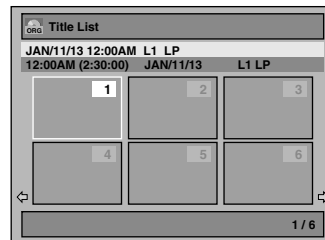

- Press [▶▶] to display the next page, and press [◀◀] to display the previous page.

### 4 Use [▲ / ▼] to select "Play From Start", then press [OK].



Playback will start.

### 5 Press [■] once to stop playback temporarily.

- Refer to "Resume Playback" on page 50.

#### Note

- Some discs may start playback automatically.
- You can also start playback by pressing [▶] instead of [OK] at step 2.

# BASIC PLAYBACK

## Playing Back an Audio CD and a CD-RW / -R with JPEG Files



### 1 Press [DVD] first. Insert a playable disc (refer to page 24 on how to insert a disc).

\* Make sure the disc is compatible with this unit.  
(Refer to page 44 for the list of compatible discs.)

#### It may take a while to load the disc.

When an audio CD is inserted, track list will appear.  
When a CD-RW/-R with JPEG files is inserted, file list will appear.

When you insert a CD-RW/-R mixed with JPEG files, the playback media selection screen will be displayed.

For JPEG, select "Photo".

- To exit the track/file list, press [■].
- To resume the track/file list, press [TOP MENU].

### 2 Use [▲ / ▼] to select a desired folder or track/file, then press [OK].

e.g.) File list

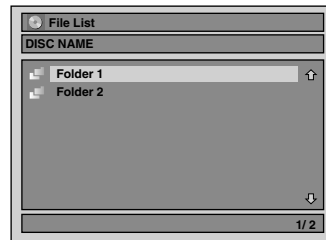

#### When selecting track/file:

Playback will start.



#### When selecting the folder (Not available for audio CD):

The files in the folder will appear.

Use [▲ / ▼] to select the file or folder you want to play back, then press [OK].

- Press [▶], [OK] or [▶] to move to any lower hierarchies.
- Press [◀] or [RETURN] to move back to the previous hierarchy.

#### Hints for audio CD tracks and JPEG files:

- Folders are shown by .
- Audio CD tracks are shown by .
- JPEG files are shown by .
- The system can recognize up to 255 folders, up to 99 tracks/999 files.
- Letters of a file/folder name overflowing the given space will be displayed as "...". Unrecognizable characters will be replaced with asterisks.
- If there are no files in the folder, "No Files" will be displayed.

**It is recommended that files to be played back in this unit are recorded under the following specifications:**

#### <JPEG>

- Upper limit : 6,300 x 5,100 dots.
- Lower limit : 32 x 32 dots.
- File size of image maximum : 12 MB.

#### Note

- Files whose extension is other than ".jpg / .jpeg (JPEG)" will not be listed.
- Some unplayable folders or files may be listed due to the recording status.
- High-resolution JPEG files take longer to be displayed.
- Progressive JPEG files (JPEG files saved in progressive format) cannot be played back on this unit.



## Playing Back an Audio CD and a CD-RW / -R with JPEG Files (cont'd)

### KODAK Picture CD

KODAK Picture CD is a service that converts and stores photographs taken by a conventional film camera into digital data and writes the data on a CD. You can enjoy your digital images on the TV by playing back the KODAK Picture CDs. For local service providers, please refer to [www.kodak.com/](http://www.kodak.com/)

#### 1) Press [TOP MENU].

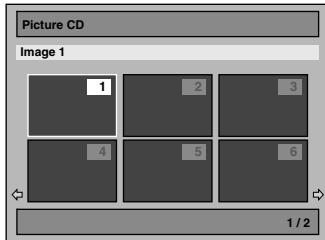

- To exit the Picture CD thumbnail List, press [RETURN] or [■].

Arrow icons mean the title list includes a next or previous page. Use [◀/▶] in the direction of the icon you wish to follow. You can quick review the six thumbnails at once between the first and last pages by pressing [◀◀] / [▶▶].

#### 2) Use [▲ / ▼ / ◀ / ▶] to select a desired track to be played back, then press [▶] or [OK].

An image will be played back from the selected track and go to the next one in turn.

#### 3) Press [■] to stop playback.

- Press [TOP MENU] to display the thumbnail again.

### Notes on JPEG and KODAK Picture CD:

- After track is displayed for 5 seconds or 10 seconds (set in "Slide Show" on page 53) the display moves to the next track.

During JPEG or KODAK Picture CD playback, press [▶] or [◀] to rotate a picture 90 degrees clockwise or counterclockwise respectively.

(Not available when the display menu appears.)

## Using the Title / Disc Menu



DVD may contain a title list, which describes the contents of the disc or a disc menu, which guides you through the available functions in the disc.

#### Press [DVD] first.

#### 1) Insert a playable disc (refer to page 24 on how to insert a disc).

- \* Make sure the disc is compatible with this unit. (Refer to page 44 for the list of compatible discs.)

**It may take a while to load the disc.**

#### 2) Press [TOP MENU] or [DISC MENU] to call up the title list or disc menu.

#### 3) Use [▲ / ▼ / ◀ / ▶] to make a selection, and then press [OK] to enable your selection.

#### 4) Press [■] to exit.

### Note

- You can select a numbered menu with [the Number buttons] also.
- Menus vary among discs. Refer to the information accompanying the disc for details.
- [TOP MENU] or [DISC MENU] will not always be active with all DVD.

## Pause

#### 1) During playback, press [II].

Playback will be paused and sound will be muted.

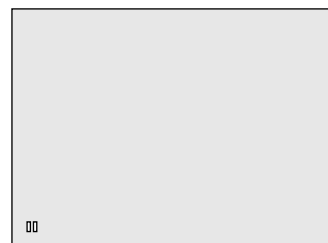

#### 2) Press [▶] to return to the normal playback.

### Note

- On DVD, set "Still Mode" to "Field" in "Playback" menu if pictures in the pause mode are blurred. (Refer to page 76.)

# SPECIAL PLAYBACK

## Resume Playback

You can play back from where you stopped playing back the disc last.

### 1) During playback, press [■].

The resume message will appear.



### 2) Press [▶].

In a few seconds, playback will resume from the point at which it last stopped. You can resume playback at the same point even if you turn the unit to the standby mode.

To cancel the resume playback and start playing back the disc from the beginning, press [■] again while the playback is stopped.

### Note

- For JPEG files, playback will resume from the beginning of the file at which playback was stopped.

## Skipping TV Commercials During Playback



You can skip TV commercials to enjoy the recorded programs without interrupting.

### During playback, press [CM SKIP].

Normal playback will start at 30 seconds ahead from the point you press [CM SKIP].

Every time you press [CM SKIP], the searching point will be extended by 30 seconds ahead.

You can press [CM SKIP] up to 6 times (180 seconds).

e.g.) Press [CM SKIP] once.

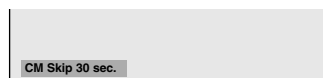

(forwarding 30 seconds)

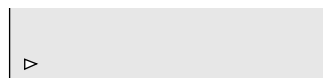

Playback will return to the normal playback.

## Fast Forward / Fast Reverse Playback



### 1) During playback, press [▶▶] or [◀◀].

Every time you press [▶▶] or [◀◀], approximate speed will be changed as follows.

Fast forward or fast reverse playback across titles (for DVD) is not possible.



For audio CD, approximate speed is fixed at 8x with sound (indicated with ▶▶▶▶ / ▶▶▶▶).

### 2) Press [▶] to return to the normal playback.

### Note

- Forward/reverse speed will be indicated with icons as follows.

forward (approx. speed)

2x: ▶▶

20x: ▶▶▶

40x: ▶▶▶▶

reverse (approx. speed)

5x: ▶▶

20x: ▶▶▶

40x: ▶▶▶▶

## Rapid Playback



### Rapid playback function is available only during playback.

This function is available only on discs recorded in the Dolby Digital format, and plays back in a slightly faster/slower speed while keeping the sound quality just as normal playback.

### 1) During playback, press [RAPID PLAY].

- ▶x0.8: Press [RAPID PLAY] once during playback. Plays back approximately at 0.8 times of normal playback.
- ▶x1.3: Press [RAPID PLAY] twice during playback. Plays back approximately at 1.3 times of normal playback.
- ▶x1: Press [RAPID PLAY] 3 times to play back in normal speed. No effects.

### 2) Press [▶] to return to the normal playback.

### Note

- Audio (language) setting cannot be changed while using this mode.
- This feature may not work at some point in a disc.
- Audio is PCM during rapid playback mode except when using digital audio connection.
- When using digital audio connection (COAXIAL), the LPCM sound (2 channel) will be output.

## Step by Step Playback



### 1) During playback, press [II].

Playback will be paused and sound will be muted.

### 2) Press [▶▶] repeatedly.

Playback will advance one frame (or step) at a time when you press [▶▶] with the sound muted.

To play back step by step backward:

Press [◀◀] repeatedly.

Every time you press the button, the playback will go backward by one frame.

- Press and hold [◀◀] / [▶▶] to reverse/ advance continuously.

### 3) Press [▶] to return to the normal playback.

## Slow Forward / Slow Reverse Playback



### 1) During playback, press [II]. Then press [▶▶] or [◀◀].

Every time you press [▶▶] or [◀◀], approximate speed will be changed as follows. (The sound will remain muted.)

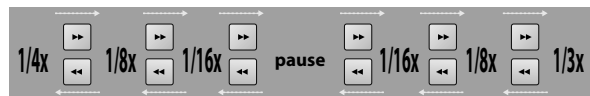

### 2) Press [▶] to return to the normal playback.

#### Note

- Forward/reverse speed will be indicated with icons as follows.

forward (approx. speed)

1/16x: ▶▶▶▶

1/8x: ▶▶▶

1/3x: ▶▶▶▶▶

reverse (approx. speed)

1/16x: ◀◀◀◀

1/8x: ◀◀◀

1/4x: ◀◀◀◀◀

## Zoom



### 1) During playback, press [DISPLAY] to bring up the display menu.

### 2) Use [◀ / ▶] to select [⊕] to display the selection menu.

e.g.) DVD-video

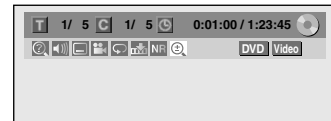

### 3) Use [▲ / ▼] to select a desired zoom factor to zoom, then press [OK].

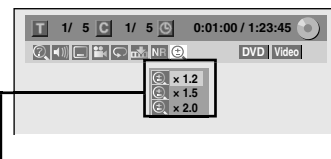

Zoom menu will appear.

There are four options

(x1.0, x1.2, x1.5 and x2.0), these are displayed excluding the current zoom rate.

Zoom area will be displayed.

### 4) Use [▲ / ▼ / ◀ / ▶] to select a desired zoom position, then press [OK].

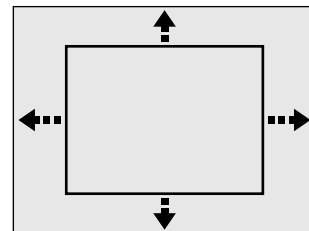

Zoom playback will start.

#### Note

- When selecting a smaller factor than the current one, the zoom area will not be displayed.
- To exit the zoom menu, press [RETURN] repeatedly at step 3.
- To cancel the zoom function, select "x1.0" using [▲ / ▼], then press [OK].
- You cannot slide the zoomed picture on some JPEG files.

# SPECIAL PLAYBACK

## Marker Setting



This feature allows you to assign a specific point on a disc to be called back later.

### 1) During playback, press [DISPLAY] to bring up the display menu.

If the display menu is already shown, skip to step 2.

### 2) Use [◀/▶] to select to display the marker list.

e.g.) DVD-video

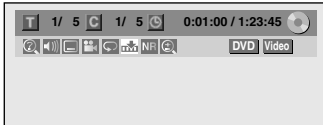

### 3) Use [▲ / ▼] to select a desired marker number. When it reaches the desired point, press [OK].

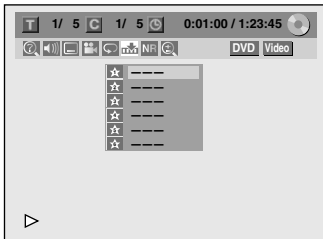

The title (track) number and the time will be displayed.

### 4) To return to the marker later:

Use [▲ / ▼] to select the desired marker number, then press [OK].

#### Note

- To clear a marker, select the marker number to be cleared, then press [CLEAR].
- All markers will be erased when you operate these operations listed below.
  - Opening the disc tray
  - Turning the unit to standby / off
  - Record on a recordable disc
- You can mark up to 6 points.

## Repeat Playback

Available repeat function may vary depending on the discs.

### 1) During playback press [DISPLAY] to bring up the display menu, then proceed to step 2) or press [REPEAT] then proceed to step 3).

If the display menu is already shown, skip to step 2.

### 2) Use [◀/▶] to select to display the selection menu.

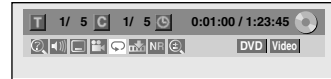

### 3) Use [▲ / ▼] to select a desired repeat type, then press [OK].

The selected repeat playback will start.

e.g.) DVD-video

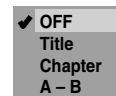

e.g.) audio CD

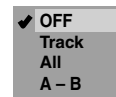

e.g.) JPEG files

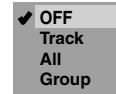

#### Title:

The current title will be played back repeatedly.

#### Chapter:

The current chapter will be played back repeatedly.

#### All:

The current disc will be played back repeatedly.

#### A-B:

Desired section can be played back repeatedly.

1) Use [▲ / ▼] to select "A-B", then press [OK].

2) Press [OK] at the desired starting point A.

3) Press [OK] at the desired ending point B.

#### Track:

The current track or file will be played back repeatedly.

#### Group:

The current folder will be played back repeatedly.

#### Note

- Point B for the repeat A-B playback should be set within the same title or track as point A.
- To cancel the repeat playback, select "OFF" at step 3. The repeat setting will also be cancelled when you stop playback.
- You cannot select "Group" during the random playback.
- During the A-B repeat, if you reaches the point A with any reverse playback, the reverse playback will be cancelled and the A-B repeat playback resumes from point A.

## Random Playback



You can play back a disc randomly instead of playing back in the original order.

- 1) Press [SETUP].
- 2) Use [▲ / ▼] to select "DISC Playback Mode", then press [OK].  
"DISC Playback Mode" menu will appear.  
For JPEG, use [▲ / ▼] to select "Photo", then press [OK].
- 3) Use [▲ / ▼] to select "Random Play", then press [OK].  
Random playback will start.

### Note

- To cancel random playback, press [■] twice during random playback. "OFF" appears on the TV screen.

## Slide Show



You can select the display time between 5 seconds and 10 seconds.

- 1) Follow steps 1 and 2 in "Random Playback" on this page.
- 2) Use [▲ / ▼] to select "Slide Show", then press [OK].
- 3) Use [▲ / ▼] to select the display time, then press [OK].
- 4) Press [SETUP] to exit.

### Note

- Large-size JPEG files take a few moments to be displayed.

## Program Playback



You can program the disc to play back in your desired order.

- 1) Press [SETUP].
- 2) Use [▲ / ▼] to select "DISC Playback Mode", then press [OK].  
"DISC Playback Mode" menu will appear.
- 3) Use [▲ / ▼] to select "Program Play", then press [OK].
- 4) Use [▲ / ▼] to select a desired track, then press [OK] or [▶].

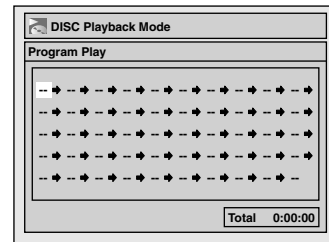

Repeat this step until you program all the desired tracks.

- 5) Press [▶].

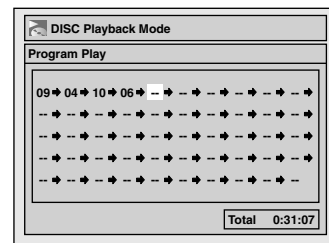

Program playback will start.

### Note

- To erase tracks you selected, press [CLEAR] at step 4.
- You can make program settings up to 50 tracks.
- To cancel program playback, press [■] twice during program playback. "OFF" appears on the TV screen.
- You may also select a desired track using [the Number buttons] at step 4.

# SEARCH

## Title / Chapter Search



### Using [◀◀] / [▶▶]

- 1) During playback, press [▶▶] to skip the current title or chapter and move to the next.

The title or chapter will move forward by one at a time.

- If there is no chapter in one title, the current title will be skipped.

To go back to the beginning of the current title or chapter, press [◀◀].

Press it repeatedly to go to the previous title or chapter. The title or chapter will move backward one at a time.

### Using [DISPLAY]

- 1) During playback, press [DISPLAY] to bring up the display menu .

- 2) Use [◀ / ▶] to select , then press [OK].

e.g.) DVD-video

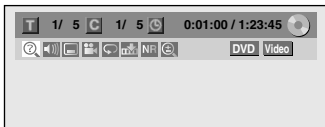

The number next to **T** will be highlighted.

- 3) Title:

Use [▲ / ▼] or [the Number buttons] to enter a desired title number to search, then press [OK].

Title search will start.

Chapter:

Press [▶] to move to the number next to **C** for chapter.

Use [▲ / ▼] or [the Number buttons] to enter a desired chapter number to search, then press [OK].

After the search, playback will start automatically.

### Note

- In search mode display, total numbers of each search contents (title/chapter/time) are shown as a denominator.

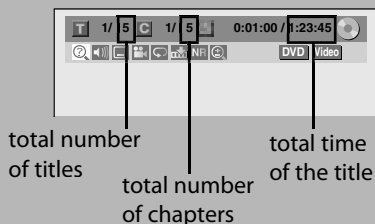

## Track Search



### Using [◀◀] / [▶▶]

- 1) During playback, press [▶▶] to skip the current track/file and move to the next.

The track/file will move forward one at a time.

To go back to the beginning of the current track/file, press [◀◀].

Press it repeatedly to go to the previous track/file. The track/file will move backward one at a time.

For JPEG files, press it once to go to the previous file.

### Using [DISPLAY]

- 1) During playback, press [DISPLAY] to bring up the display menu.

If the display menu is already shown, skip to step 2.

- 2) Use [◀ / ▶] to select , then press [OK].

e.g.) audio CD

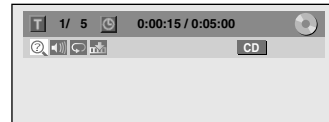

The number next to **T** will be highlighted.

- 3) Use [▲ / ▼] or [the Number buttons] to enter a desired track/file number to search, then press [OK].

After the search, playback will start automatically.

### Note

- During CD playback you can enter a track number directly using [the Number buttons] for track search without displaying the menu.

## Time Search



1) During playback, press [DISPLAY] to bring up the display menu.

If the display menu is already shown, skip to step 2.

2) Use [◀/▶] to select , then press [OK].

e.g.) DVD-video

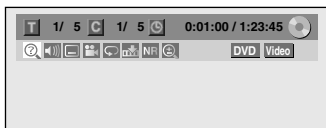

e.g.) audio CD

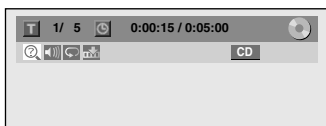

The number next to  will be highlighted.

To move to the number next to , Press [▶].

When time search is not available,  and time counter are not displayed.

3) Use [▲ / ▼ / ▶ / ◀] or [the Number buttons] to enter a desired time to search, then press [OK].

After the search, playback will start automatically.

### Note

- Time search is available only in the same track, file or title.

# SELECTING THE FORMAT OF AUDIO AND VIDEO

You can select the format of audio and video as you prefer depending on the contents of the disc you are playing back.

## Switching Subtitles



DVD-video may have subtitles in 1 or more languages. Available subtitle languages can be found on the disc case. You can switch subtitle languages anytime during playback.

1) During playback, press **[DISPLAY]** to bring up the display menu.

2) Use **[◀/▶]** to select  to display the selection menu.

e.g.) DVD-video

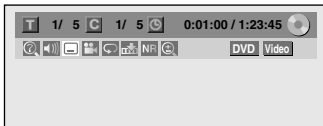

3) Use **[▲/▼]** to select a desired subtitle language, then press **[OK]**.

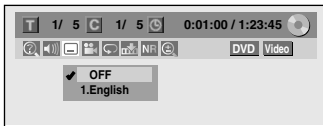

Subtitle will be displayed in the selected language. When selecting "OFF", subtitle will disappear.

### Note

- Some discs will only allow you to change the subtitle from the disc menu. Press **[TOP MENU]** or **[DISC MENU]** to display the disc menu.
- If a 4-digit language code appears in the subtitle menu, refer to "LANGUAGE CODE" on page 88.

## Switching Audio Soundtrack



When playing back a DVD-video recorded with 2 or more soundtracks (these are often in different languages), you can switch them during playback.

When playing back audio CD you can switch "L/R"(stereo), "L"(left) or "R"(right).

1) During playback press **[DISPLAY]** to bring up the display menu, then proceed to step 2) or press **[AUDIO]** then proceed to step 3).

- If the display menu is already shown, skip to step 2.

2) Use **[◀/▶]** to select  to display the selection menu.

3) Use **[▲/▼]** to select a desired audio soundtrack or audio channel, then press **[OK]**.

For DVD-video

- Audio soundtrack will switch.

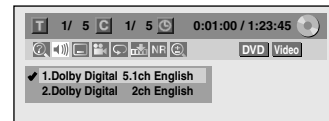

- If the title contains both main and sub audio, you can further select "L" (main), "R" (sub) or "L/R" (mixed of main and sub).

For audio CD

- Audio channel will switch.

e.g.) audio CD

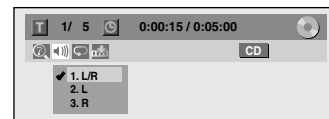

### Note

- Some discs will only allow you to change the soundtrack from the disc menu. Press **[TOP MENU]** or **[DISC MENU]** to display the disc menu.



## Switching Camera Angles



Some DVD-video have scenes shot from 2 or more angles. Angle information should be on the disc case if the disc contains multi-angle scenes.

1) During playback, press [DISPLAY] to bring up the display menu.

2) Use [◀/▶] to select , then press [OK].

e.g.) DVD-video

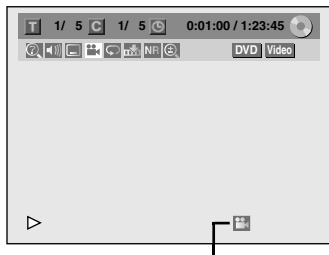

Angle icon appears when a switching camera angle is available.

Angle will switch each time you press [OK].

### Note

- Angle icon does not appear on the TV screen if the "Angle Icon" is set to "OFF" in the "Playback" menu. Refer to page 76.

## Reducing Block Noise



This function reduces noise in the playback picture.

1) During playback, press [DISPLAY] to bring up the display menu.

2) Use [◀/▶] to select **NR** to display the selection menu.

e.g.) DVD-video



3) Use [▲/▼] to select a desired option, then press [OK].

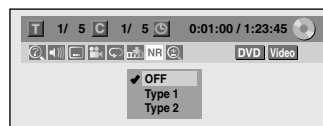

Your setting will be activated.

**OFF** : When playing back titles with a few noises such as DVD-video.

**Type 1** : For the titles recorded in long time mode such as EP or SLP mode.

**Type 2** : Same as type 1, only more effective.

# INFORMATION ON DISC EDITING

## Guide to a Title List

Title list allows you to check the titles recorded on the disc easily. You can choose a title to play back from this list and easily edit the titles as you prefer.

Press [DVD], then press [TOP MENU].

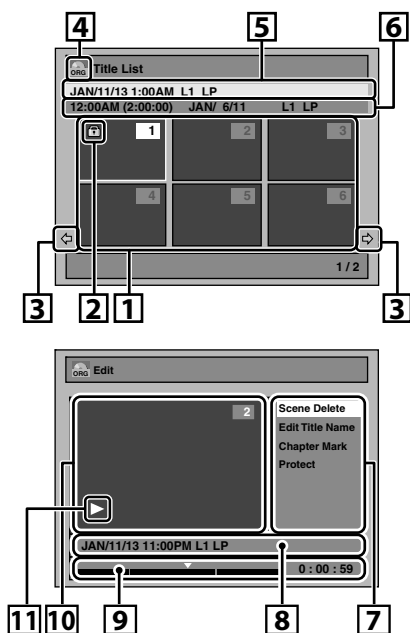

- 1. Title list:** List of the titles recorded on the disc, and their information.
- 2. The protect icon:** Appears when the title has been protected. (Original titles only)
- 3. Arrow:** Indicating there is a previous / next page.
- 4. Title list icon:** Indicates a type of the displayed title list.  
ORG : VR (Original)  
PL : VR (Playlist)      Video : Video mode
- 5. Title name**
- 6. Title information:** Displays various information on the selected title.
- 7. Submenu:** Submenus for the selected menu are displayed here.
- 8. Title name (editable):** If you do not name the title, the recorded date, time and the recording mode are displayed here.
- 9. Progress bar:** Indicating the progress of the playback. The vertical lines in the bar indicates chapter marks, and "▼" sliding on the bar indicates current point of playback displayed in the preview window.
- 10. Preview window:** Preview of the selected title is displayed here.
- 11. Playback status:** Indicating the current playback status of the selected title.

Press [■] to exit the title list.

## Editing Discs

You can edit discs for the following items. Be sure that once you edit titles, they will not remain as original.

- Adding Titles to a Playlist (Refer to page 61.)
- Erasing All Playlists (Refer to page 62.)
- Deleting a Title (Refer to page 63.)
- Deleting a Part of a Title (Refer to page 64.)
- Putting Names on Titles (Refer to page 66.)
- Setting Chapter Marks (Refer to page 67.)
- Clearing Chapter Marks (Refer to page 68.)
- Dividing a Title (DVD-RW only) (Refer to page 69.)
- Combining Titles (Refer to page 70.)
- Setting or Releasing the Title Protection (Refer to page 71.) (Possible editing functions depend on the recording format and editing method.)

### Original and playlist (VR mode)

For VR mode DVD-RW, you can edit the recordings in playlist without changing the original recordings. Playlist does not take up much disc space. After you make a recording to VR mode DVD-RW, a playlist will be created automatically.

### What "Original" or "Playlist" is for?

Throughout this manual, you will find original and playlist which refer to the actual content and the edited version.

- **Original** content refers to what's actually recorded in the VR mode on a DVD-RW.
  - **Playlist** content refers to the edited version of the VR mode DVD-RW; how the original content is to be played back.
- ### Finalizing a disc
- This will allow a disc that is recorded on this unit to be played back on other DVD player — without finalization it will not be playable on other DVD player.
  - After finalizing a DVD-RW/-R, you cannot edit any information that is on that disc.

### Note

- When selecting "Edit" on pop-up menu of the title list and edit the title, the title list is displayed after writing the edited contents onto the disc.
- The capacity indicator in the right side of the title list may not indicate the precise capacity in the disc.
- The capacity indicator may not indicate the capacity for the titles of which recording time is short.
- Once you have finalized a DVD-R, you cannot edit or record anything on that disc.

# FORMATTING A DISC

## Choosing the Recording Format of a Brand-New DVD-RW



When inserting a brand-new DVD-RW, the unit automatically starts to initialize the disc. DVD-RW will be formatted either video or VR mode according to the recording format mode setting of the unit. Before inserting a brand-new DVD-RW, you need to set the recording format to the desired mode. You can also manually format a DVD-RW once it has been used.



**1** Press [SETUP].

**2** Use [▲ / ▼] to select "DVD Menu", then press [OK].

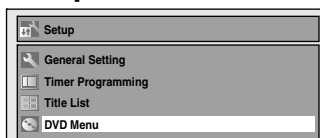

**3** Use [▲ / ▼] to select "Format", then press [OK].



**4** Use [▲ / ▼] to select "Format Mode", then press [OK].

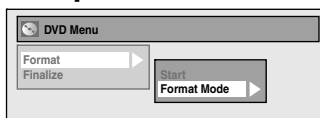

**5** Use [▲ / ▼] to select "Video mode" or "VR mode", then press [OK].

**6** Press [SETUP] to exit.

**7** Insert a brand-new disc.  
Formatting will start.



**8** Formatting is completed.  
"100%" is indicated.

### Note

The recording format setting is effective only for DVD-RW. You cannot change the recording format for a DVD-R.

You cannot mix two formats on one DVD-RW disc. If you insert a disc that has been formatted before, the recording format is not changed if you select another format in the "Setup" menu only. To reformat a disc (change disc format type), refer to "Reformatting a Disc Manually" on page 60.

# FORMATTING A DISC

## Reformatting a Disc Manually



If you are using a DVD-RW, you can format the disc by performing "Format". You can format DVD-RW for either video mode recording or VR mode recording.



### Insert a recordable disc.

**1** Press [SETUP].

**2** Use [▲ / ▼] to select "DVD Menu", then press [OK].

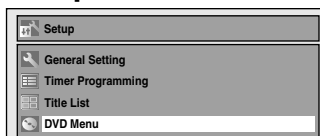

**3** Use [▲ / ▼] to select "Format", then press [OK].  
e.g.) VR mode DVD-RW

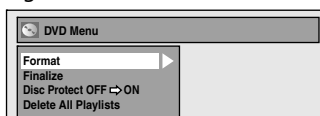

**4** Use [▲ / ▼] to select "Start", then press [OK].



Selection menu will appear and prompt you to confirm.

**5** Use [▲ / ▼] to select "Yes", then press [OK].

Formatting will start.

If you want to cancel formatting, select "No".

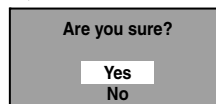

**6** Formatting is completed.  
"100%" is indicated.



### Note

When you reformat the disc, the contents of the disc are erased.

For DVD-RW, make sure that the recording format is set to the desired mode. (See steps 1 to 6 in "Choosing the Recording Format of a Brand-New DVD-RW" on page 59.)

This unit may not be able to reformat a disc that is not previously formatted by this unit (e.g. DVD disc formatted by PC or another recorder).

# CREATING/DELETING PLAYLIST

## Adding Titles to a Playlist



For VR mode DVD-RW, you can create the playlist as you wish.

You can add up to 99 titles to a playlist (as long as the total number of the playlist does not exceed 999 chapters).



- 1 Press [DVD].**  
**Press [TOP MENU].**
  - If the "Playlist" screen appears, press [DISC MENU] to switch the "Original" screen.

- 2 Use [▲ / ▼ / ◀ / ▶] to select the desired title, then press [OK].**

- 3 Use [▲ / ▼] to select "Add To Playlist", then press [OK].**



- 4 Use [▲ / ▼] to select "Yes", then press [OK].**



The title is added to playlist.

- 5 Press [RETURN] or [■] to exit.**  
Data will be written onto the disc momentarily.

**This operation may take awhile to be completed.**

### Note

When a playlist contains 99 titles or more or 999 chapters or more, "Add to Playlist" cannot be selected.

# CREATING/DELETING PLAYLIST

## Erasing All Playlist



A playlist can be deleted if it is no longer needed.



**1** Press [DVD].  
Press [SETUP].  
Main menu will appear.

**2** Use [▲ / ▼] to select "DVD Menu",  
then press [OK].

**3** Use [▲ / ▼] to select "Delete All  
Playlists", then press [OK].



**4** Use [▲ / ▼] to select "Yes", then press [OK].

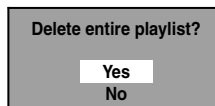

"Are you sure?" will appear.

Use [▲ / ▼] to select "Yes" and then press [OK].

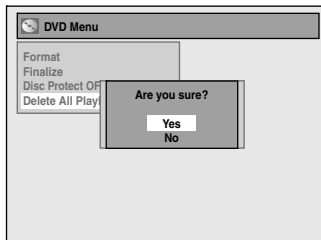

Playlist is deleted.

Data will be written onto the disc momentarily.

**This operation may take  
awhile to be completed.**

### Note

Deleting a playlist will not increase the available recording time on the disc.

# DELETING TITLES



You can delete a title which you do not need anymore. Please be advised that the titles once deleted cannot be brought back to the disc.

For DVD-RW, when the last recorded title in the title list is deleted, the available disc space to record on will be increased. For DVD-R, the disc space to record on will not be changed.



## 1 Press [DVD]. In stop mode, press [TOP MENU].

Title list original or playlist will appear.

- For VR mode DVD-RW, press [DISC MENU] to switch between "Original" and "Playlist".

## 2 Use [▲ / ▼ / ◀ / ▶] to select the desired title, then press [OK].

e.g.) VR mode DVD-RW original

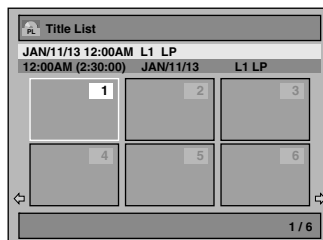

## 3 Use [▲ / ▼] to select "Title Delete", then press [OK].

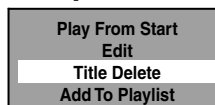

## 4 Use [▲ / ▼] to select "Yes", then press [OK].

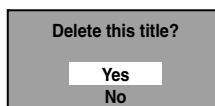

After that, "Are you sure?" will appear, select "Yes" and then press [OK].

Title will be deleted.

## 5 Press [RETURN] or [STOP ■] to exit.

Data will be written onto the disc momentarily.



**This operation may take awhile to be completed.**

## Deleting a Part of a Title



You can delete a specific part of a title. Even when parts of title are deleted from the playlist, the original title will remain as it is.



### 1 Press [DVD]. In stop mode, press [TOP MENU].

Title list original or playlist will appear.

- For VR mode DVD-RW, press [DISC MENU] to switch between "Original" and "Playlist".

### 2 Use [▲ / ▼ / ◀ / ▶] to select the desired title, then press [OK].

e.g.) VR mode DVD-RW original

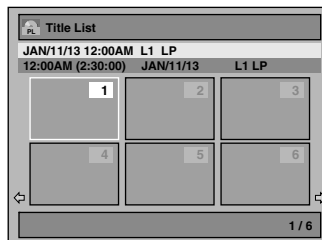

### 3 Use [▲ / ▼] to select "Edit", then press [OK].

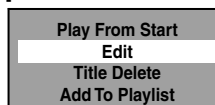

### 4 Use [▲ / ▼] to select "Scene Delete", then press [OK].

e.g.) VR mode DVD-RW playlist.

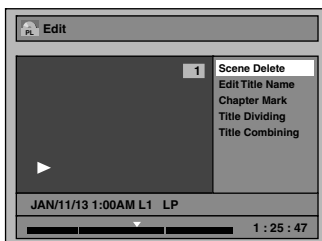

Instructions continue on the next page.

#### Note

When a scene is deleted from an original, the playlist related to the original will be deleted.

You cannot select "Scene Delete" if the number of chapter marks in the original or playlist is more than 999. (Depends on the content, there is a case that you cannot select "Scene Delete" before the number of chapter marks reaches 999.)

The recordable disc space will not increase even after deleting a part of a title on the playlist.



**5** Use [**◀◀** / **▶▶**], [**◀**], [**▶**], [**▶▶**] and [**⏏**] to find the start point, then press [**OK**].

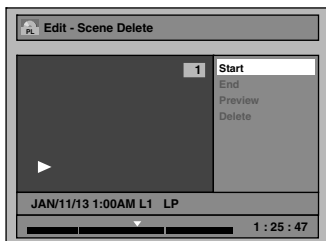

Then use [**◀◀** / **▶▶**], [**◀**], [**▶**], [**▶▶**] and [**⏏**] again to move to the end point, and press [**OK**].

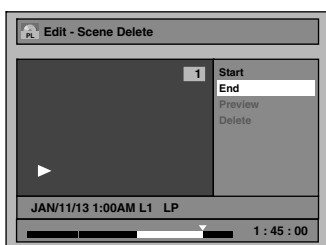

The cursor will move to "Preview".

The bar at the bottom of the screen indicates the total and the elapsed time of the title, and the area selected for deletion is indicated in red.

You can check the preview by pressing [**OK**].

- Before and after 5 seconds of the deleted point will be played back for preview.

**6** Use [**▲** / **▼**] to select "Delete" then press [**OK**].

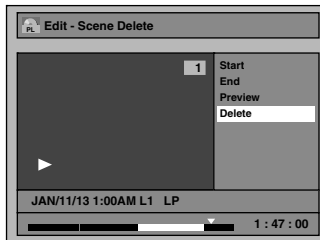

**7** Use [**▲** / **▼**] to select "Yes" then press [**OK**].

"Are you sure?" will appear. Select "Yes" using [**▲** / **▼**] and then press [**OK**].

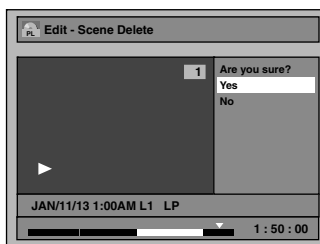

The part of the title is deleted.

**8** Press [**RETURN**] and then [**RETURN**] or [**■**] to exit.

Data will be written onto the disc momentarily.

**This operation may take awhile to be completed.**

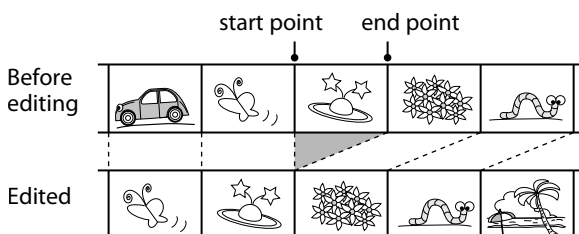

## Putting Names on Titles



You can put title names on the titles and change the names from this menu.



**1** Follow steps 1 to 3 in “DELETING TITLES” on page 63 to display “Edit” menu.

**2** Use [▲ / ▼] to select “Edit Title Name”, then press [OK].

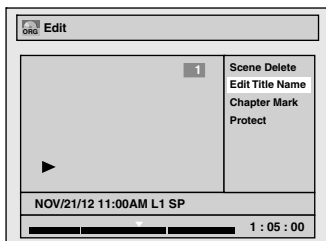

**3** To enter a title name, follow the steps of “Guide to Edit Title Name” on this page.

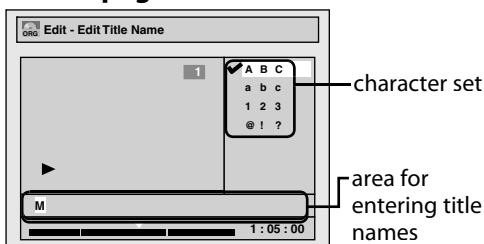

• When you finish entering a title name, press [OK].

**4** Use [▲ / ▼] to select “Yes”, then press [OK].

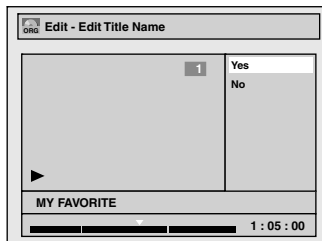

The name you entered will be activated for the title.

**5** After this operation is completed, press [RETURN] to exit. Data will be written onto the disc momentarily.

**This operation may take awhile to be completed.**

### Guide to Edit Title Name

1) Use [▲ / ▼] to select a desired character set, then press [OK].

2) Follow the list below, use [the Number buttons] repeatedly until the desired letter appears. When you finish entering a title name, press [OK].

Select Press	ABC	abc	123	@!?
0	<space>	<space>	0	<space>
1	(*1)	(*1)	1	!"#\$%&'()* *+,-./:;<=> ?@[ ]^_`{ }
2	ABC	abc	2	
3	DEF	def	3	
4	GHI	ghi	4	
5	JKL	jkl	5	
6	MNO	mno	6	
7	PQRS	pqrs	7	
8	TUV	tuv	8	
9	WXYZ	wxyz	9	

\*1 Press [1], character set will be changed to “@!?” mode automatically. Press [2] to [9] to back to the previous character set.

- To delete letters, press [CLEAR] repeatedly. Holding [CLEAR] to delete all letters.
- Use [◀ / ▶] to move the cursor to the left and right.
- You can enter up to 30 letters.

### Note

- Undefined letters in a title name are shown by “\*” . If you delete them, adjoining letters may change to “\*” or others.

## Setting Chapter Marks



You can put chapter marks in each title. Once a chapter is marked, you can use it for the chapter search feature.



- 1** Follow steps 1 to 3 in “DELETING TITLES” on page 63 to display “Edit” menu.
- 2** Use [▲ / ▼] to select “Chapter Mark”, then press [OK].  
Submenu will appear.
- 3** Use [SKIP |◀◀ / ▶▶|], [REV ◀◀], [FWD ▶▶], [PLAY ▶] and [PAUSE ||] to find the point where you will create a new chapter mark.  
Or, use [SKIP |◀◀ / ▶▶|] to find a chapter mark that you wish to delete.

- 4** Use [▲ / ▼] to select “Add” or “Delete”, then press [OK].  
e.g.) VR mode DVD-RW original

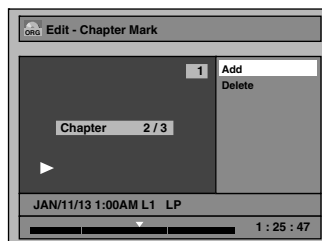

- 5** Use [▲ / ▼] to select “Yes”, then press [OK].  
If you select “Add” at step 4, a new chapter mark will be added, and if you select “Delete” at step 4, the chapter mark will be deleted.  
e.g.) Add

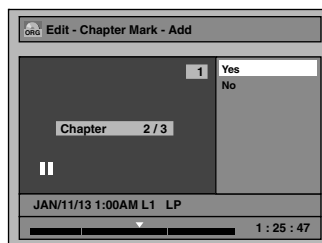

A new chapter mark will be added.

- 6** Press [RETURN].

- 7** Press [RETURN] again and then [RETURN] or [STOP ■] to exit.  
Data will be written onto the disc momentarily.

**This operation may take awhile to be completed.**

### Note

Maximum numbers of chapter for each DVD:

VR mode DVD : 999 chapters per entire original and playlist

Besides the above-mentioned, it is not likely to be able to add according to recorded time and number of chapters.

## Setting or Clearing All Chapter Marks at Once



For titles in video mode DVD-RW, you can set or edit chapters at every time interval. You can clear the chapter mark too.

You can specify the interval of chapter marks for titles last more than 5 minutes.



**1** Follow steps 1 to 3 in “DELETING TITLES” on page 63 to display “Edit” menu.

**2** Use [▲ / ▼] to select “Chapter Mark”, then press [OK].

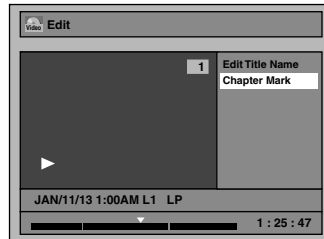

**3** Use [▲ / ▼] to select the desired interval, then press [OK].

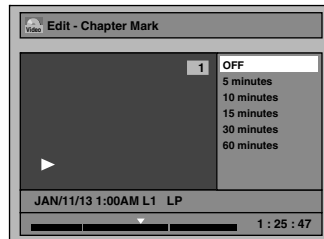

**4** Use [▲ / ▼] to select “Yes”, then press [OK].

Chapter marks are added.

If you select “OFF” at step 3, all the chapter marks are erased.

**5** Press [RETURN] and then [RETURN] or [STOP ■] to exit.

Data will be written onto the disc momentarily.

**This operation may take awhile to be completed.**

### Note

You cannot select a chapter mark interval that exceeds the length of a title.

The length of chapters may slightly deviate from the one specified at the step 3.

A chapter mark may be delayed depending on the recording content.

Maximum number of chapter for video mode DVD is 99 chapters per title.

The interval for auto chapter may be up to two minutes different from the time option you set.

## Dividing a Title



You can divide one title into two new titles.



**1 Press [DVD].**  
**In stop mode, press [TOP MENU].**  
 • For VR mode DVD-RW, press [DISC MENU] to select "Playlist".

**2 Use [▲ / ▼ / ◀ / ▶] to select a desired title, then press [OK].**

**3 Use [▲ / ▼] to select "Edit", then press [OK].**  
 e.g.) VR mode DVD-RW playlist

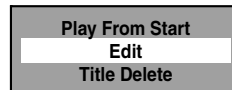

**4 Use [SKIP ◀◀], [SKIP ▶▶], [REV ◀◀], [FWD ▶▶], [PAUSE ||] and [PLAY ▶] to decide the point at which you will divide the title.**

**5 Use [▲ / ▼] to select "Title Dividing", then press [OK].**

**6 Use [▲ / ▼] to select "Yes", then press [OK].**  
 e.g.) VR mode DVD-RW playlist

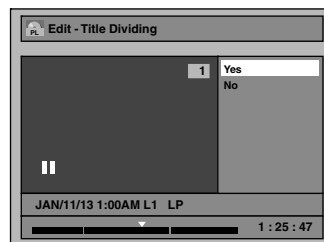

The title will be divided into two new titles. Both title names are identical.



**This operation may take awhile to be completed.**

For VR mode DVD-RW: Proceed to step 7.

**7 Press [RETURN] or [STOP ■] to exit.**  
 Data will be written onto the disc momentarily.

**This operation may take awhile to be completed.**

### Note

You cannot divide a title on the disc when the number of recording titles reaches the maximum of 99, and the number of recording chapters reaches the maximum of 999.

## Combining Titles



You can combine two titles into a single title.



**1** Follow steps 1 to 3 in “Dividing a Title” on page 69 to display “Edit” menu.

**2** Use [▲ / ▼] to select “Title Combining”, then press [OK].

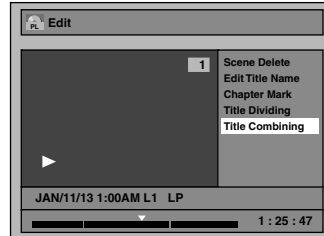

Title combining setting window will appear. Selected title grays out, and the frame of the next title becomes yellow.

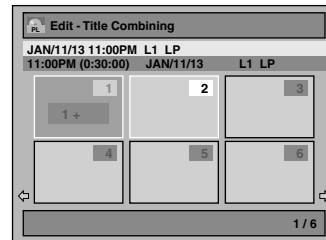

**3** Use [▲ / ▼ / ◀ / ▶] to select another title to combine, then press [OK]. Selection menu will appear.

**4** Use [▲ / ▼] to select “Yes”, then press [OK].

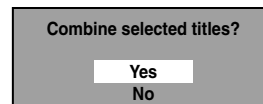

The two titles will combine into a single title.

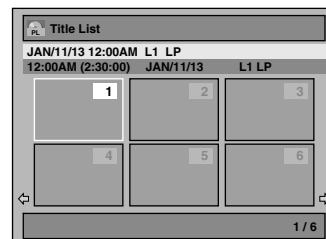

**5** Press [RETURN] or [■] to exit. Data will be written onto the disc momentarily.

**This operation may take awhile to be completed.**

### Note

You cannot select the same title twice and combine it into a single title.  
If either one of the two original titles is deleted, the combined new title is also deleted.

## Setting or Releasing the Title Protection



To prevent the accidental editing or erasing of the titles, you can protect them in "Edit" menu.

You can cancel the title protection feature after it is applied.



**1** Follow the steps 1 to 3 in "Putting Names on Titles" on page 66 to display "Edit" menu.

**2** Use [▲ / ▼] to select "Protect", then press [OK].

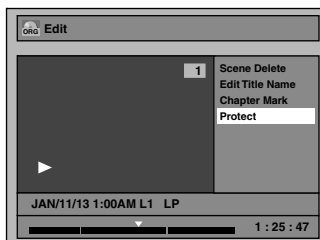

- If the title is protected, icon will appear in the original list.

**3** Confirm the indication "OFF ⇒ ON". Press [OK] again.

- If the title is already protected, "ON ⇒ OFF" will appear. If you press [OK], the title will be released from protection.

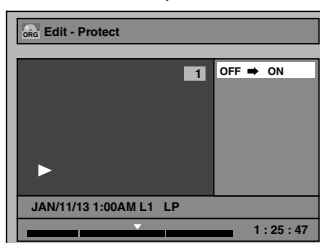

- icon will appear on the title in the original list.

**4** Press [RETURN] and then [RETURN] or [STOP ■] to exit.

Data will be written onto the disc momentarily.

**This operation may take awhile to be completed.**

**To protect a whole disc (VR mode DVD-RW only):**

Select "Disc Protect OFF ⇒ ON" from the DVD Menu, then select "Yes".

Refer to "SETTING A DISC TO PROTECT" on page 41.

# LIST OF SETTINGS

The following table is the contents which you can set and the default setting.  
Refer to the following table for useful operation.

Setup	Items (highlight is the default)		Contents		
General Setting	Playback → Pages 74-76	Parental Lock	OFF level 8 [Adult] to 1 [Kid Safe]	Set the parental level for DVD playback.	
		Audio Out	Dynamic Range Control	ON OFF	Compressing the range of sound volume.
			PCM	48kHz 96kHz	Set whether the sound recorded in 96kHz will be down sampled in 48kHz.
			Dolby Digital	PCM Stream	Set the type of sound signal which outputs from the digital audio output jack.
		Disc Menu Language	English French Spanish Other	Set the language for disc menu language.	
		Audio Language	Original English French Spanish Other	Set the language for audio.	
		Subtitle Language	OFF English French Spanish Other	Set the language for subtitles.	
	Angle Icon	ON OFF	Set whether or not to display the angle icon.		
	Still Mode	Auto Field Frame	Set the type of still image in pausing playback.		
	Display → Pages 77	OSD Language	English Français Español	Set the language for OSD (on-screen display).	
Screen Saver		OFF 1 minute 5minutes 10minutes 15minutes	Set the idling time before the screen saver starts.		
FL Dimmer		Auto Bright Dark	Set the brightness of the front panel display.		
Video → Page 78	Progressive Scan	ON OFF	Set to the progressive scan mode (set to "ON") or to the interlace scan mode (set to "OFF").		
	TV Aspect	4:3 Letter Box 4:3 Pan & Scan 16:9 Wide	Set a picture size according to aspect ratio of your TV.		
	Select Video → Page 37	L1(Rear)	Video In S-Video In	Set the video input type for the external input.	
L2(Front)		Video In S-Video In			

Instructions continue on the next page.



# LIST OF SETTINGS

Setup	Items (highlight is the default)	Contents		
General Setting	Recording Auto Chapter → Page 28	OFF 5 minutes 10 minutes 15 minutes 30 minutes 60 minutes	Insert chapter marks at time intervals.	
	Recording Audio Select (XP) → Page 28	PCM Dolby Digital	Set the recording audio type. (Only when the rec mode is set to XP.)	
	Auto Finalize → Page 43	Disc Full ON OFF	Set the unit to finalize the disc automatically.	
	End of Timer Rec	ON OFF		
	Aspect Ratio (Video mode) → Page 28	Auto 4:3 16:9	Set an aspect ratio for video mode recording.	
	Dubbing Mode → Pages 39-40	VCR → DVD DVD → VCR	Set the dubbing direction.	
	Clock → Page 26	Clock Setting	Set the clock.	
	HDMI → Page 79	Format	RGB YCbCr	Set the color space for the HDMI output.
		HDMI Audio	ON OFF	Set whether to output the HDMI audio signal or not.
		RGB Range	Normal Enhanced	Set the black-white contrast level for HDMI RGB output.
Reset All → Page 80	Yes No	Set to the default setting.		

## Note

- Your change to each setting stays on even when the power is off except for Dubbing Mode.
- An item which is not currently available is grayed in the settings.



Press [■] if you are playing back a disc.

**1** Press [SETUP] and use [▲ / ▼] to select "General Setting", then press [OK].

"General Setting" menu will appear.

**2** Use [▲ / ▼] to select "Playback", then press [OK].

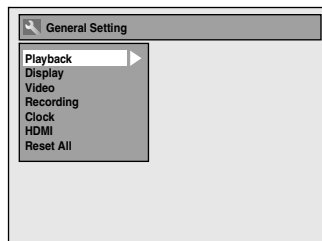

**3** Use [▲ / ▼] to select a desired item, then press [OK].

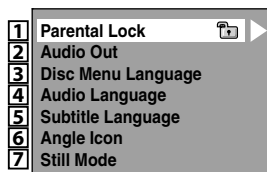

Submenu will appear.

**4** Refer to [1] to [7] on pages 75-76 and set the selected item.

**5** When you finish with setting, press [SETUP] to exit.

## Playback (cont'd)

### 1 Parental Lock (Default: OFF)

Some DVD-video feature a parental lock level. Playback will stop if the ratings exceed the levels you set, it will require you to enter a password before the disc will playback. This feature prevents your children from viewing inappropriate material.

Use **[▲ / ▼]** to select the desired level, then press **[OK]**.

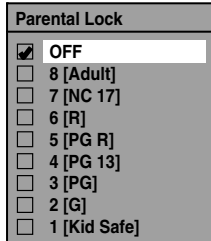

If a password has not been set yet, proceed to **A**.

If a password has been set already, proceed to **B**.

#### Note

- Parental lock function may not be available to some discs.
- With some DVD, it may be difficult to find if they are compatible with parental lock. Be sure to check if the parental lock function operates in the way that you have set.
- Record the password in case you forget it.
- If there is a DVD in the unit when you set up the parental lock, press **[▲]** to activate the parental lock level.

**A** A password has not been set yet.

Use **[▲ / ▼]** to select "Yes". Use **[the Number buttons]** to enter a new password except for 4737, then press **[OK]**.

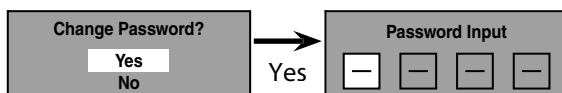

Your setting will be activated.

**B** A password has been set already.

• Use **[the Number buttons]** to enter the current password.



Your setting will be activated.

• If you want to change password, use **[▲ / ▼]** to select "Yes". Use **[the Number buttons]** to enter a new password except for 4737, then press **[OK]**.

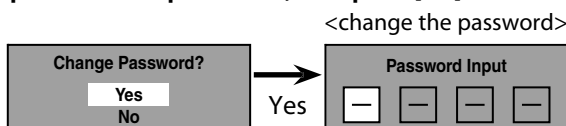

Your setting will be activated.

#### Note

- Press **[CLEAR]** to erase numbers entered incorrectly.
- When you forget the password or you want to clear all settings in "Parental Lock" menu, enter 4737 using **[the Number buttons]** in password input window. Password will be cleared and parental levels will be set to "OFF".

### 2 Audio Out

Choose the appropriate audio setting for your external device.

It will only affect a disc playback.

Use **[▲ / ▼]** to select a desired item, then press **[OK]**.

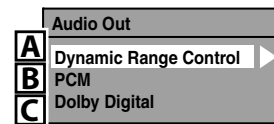

**A** Dynamic Range Control (Default : ON)

Set to "ON" to compress the range between soft and loud sounds.

Use **[▲ / ▼]** to select a setting, then press **[OK]**.

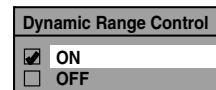

Your setting will be activated.

#### Note

- Dynamic range control function is available only on the discs which are recorded in the Dolby Digital format.

**B** PCM (Default : 48kHz)

Use **[▲ / ▼]** to select a setting, then press **[OK]**.

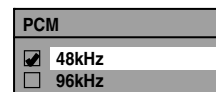

Your setting will be activated.

**48kHz** : If your amplifier/decoder is NOT compatible with 96kHz PCM, select "48kHz". 96kHz sound will be output in 48kHz.

**96kHz** : If your amplifier/decoder is compatible with 96kHz PCM, select "96kHz". 96kHz sound will be output.

#### Note

**When playing back disc with copyright protection**

- Even if you select "96kHz", the sound will be down sampled at 48kHz.

Instructions continue on the next page.

## Playback (cont'd)

### C Dolby Digital (Default : Stream)

Use [▲ / ▼] to select a setting, then press [OK].

Dolby Digital	
<input type="checkbox"/>	PCM
<input checked="" type="checkbox"/>	Stream

Your setting will be activated.

**PCM** : Converts the Dolby Digital into PCM (2 channel).  
When your amplifier/decoder is NOT compatible with Dolby Digital, set to "PCM".

**Stream** : Outputs Dolby Digital signals  
When your amplifier/decoder is compatible with Dolby Digital, set to "Stream".

### 3 Disc Menu Language (Default : English)

Set the language for disc menu.

Use [▲ / ▼] to select a setting, then press [OK].

Disc Menu Language	
<input checked="" type="checkbox"/>	English
<input type="checkbox"/>	French
<input type="checkbox"/>	Spanish
<input type="checkbox"/>	Other

Your setting will be activated.

### 4 Audio Language (Default : Original)

Set the audio language.

Use [▲ / ▼] to select a setting, then press [OK].

Audio Language	
<input checked="" type="checkbox"/>	Original
<input type="checkbox"/>	English
<input type="checkbox"/>	French
<input type="checkbox"/>	Spanish
<input type="checkbox"/>	Other

Your setting will be activated.

• When "Original" is selected, the audio language will be in the disc's default language.

### 5 Subtitle Language (Default : OFF)

Set the subtitle language.

Use [▲ / ▼] to select a setting, then press [OK].

Subtitle Language	
<input checked="" type="checkbox"/>	OFF
<input type="checkbox"/>	English
<input type="checkbox"/>	French
<input type="checkbox"/>	Spanish
<input type="checkbox"/>	Other

Your setting will be activated.

If "Other" is selected for **3** to **5**, press 4-digit code using [the Number buttons]. Refer to the language code table on page 88.

Code Input			
-	-	-	-

• When you finish entering the code, press [OK].

### Note

- Only the languages supported by the disc can be selected.
- Audio language setting may not be available on some discs.
- You can change or switch off the subtitles on a DVD also from the disc menu if it is available.
- Press [CLEAR] or [◀] to erase numbers entered incorrectly.

### 6 Angle Icon (Default : ON)

Set to "ON" to show the angle icon during the playback.

Use [▲ / ▼] to select a setting, then press [OK].

Angle Icon	
<input checked="" type="checkbox"/>	ON
<input type="checkbox"/>	OFF

Your setting will be activated.

### 7 Still Mode (Default : Auto)

Select "Auto" usually.

Use [▲ / ▼] to select a setting, then press [OK].

Still Mode	
<input checked="" type="checkbox"/>	Auto
<input type="checkbox"/>	Field
<input type="checkbox"/>	Frame

Your setting will be activated.

**Auto** : Optimum resolution setting ("Field" or "Frame") will be selected.

**Field** : Images in the still mode will be stabilized.

**Frame** : Images in the still mode will be highly defined.

### Note

- Frame is 1 completed video image made up of 2 fields (There are 30 frames per second of NTSC video).



Press **[■]** if you are playing back a disc.

**1** Press **[SETUP]** and use **[▲ / ▼]** to select “General Setting”, then press **[OK]**.

**2** Use **[▲ / ▼]** to select “Display”, then press **[OK]**.

**3** Use **[▲ / ▼]** to select a desired item, then press **[OK]**.

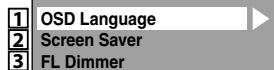

Selection menu will appear.

**4** Refer to **1** to **3** on this page and set the selected item.

**5** When you finish with setting, press **[SETUP]** to exit.

### **1** OSD Language (Default : English)

Set the language for the on-screen display.

Use **[▲ / ▼]** to select a setting, then press **[OK]**.



Your setting will be activated.

### **2** Screen Saver (Default : 10 minutes)

Set the time to activate the screen saver function on the TV screen.

Use **[▲ / ▼]** to select a setting, then press **[OK]**.

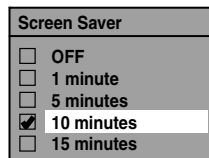

Your setting will be activated.

### **3** FL Dimmer (Default: Bright)

Set the front panel display brightness.

Use **[▲ / ▼]** to select a setting, then press **[OK]**.

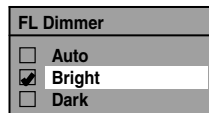

You can choose one from “Auto”, “Bright” and “Dark”. If “Auto” is selected, the display gets dark when the power is in the standby mode.



Press **[■]** if you are playing back a disc.

**1** Press **[SETUP]** and use **[▲ / ▼]** to select **"General Setting"**, then press **[OK]**.

**2** Use **[▲ / ▼]** to select **"Video"**, then press **[OK]**.

**3** Use **[▲ / ▼]** to select a desired item, then press **[OK]**.

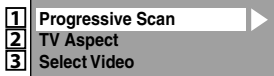

Submenu will appear.

**4** Refer to **1** to **2** on this page and set the selected item.

• For **3** refer to page 37.

**5** When you finish with setting, press **[SETUP]** to exit.

### 1 Progressive Scan (Default : OFF)

This unit is compatible with the progressive scan system. The feature provides you with the higher definition images than the traditional output system does. To utilize this feature, you must set progressive scan mode to "ON".

1) Use **[▲ / ▼]** to select **"ON"**, then press **[OK]**.

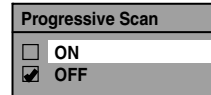

2) Use **[◀ / ▶]** to select **"Yes"**, then press **[OK]**.

Activating progressive scan:  
Check your TV has progressive scan and connect with component video cable.

**NOTE :**

If there is no picture or picture is distorted after selecting "Yes",  
Wait about 15 seconds for auto recovery.

Activate? Yes No

3) Use **[▲ / ▼]** to select **"Yes"** within 15 seconds (if the picture is OK), then press **[OK]**.  
Your setting will be activated.

#### Note

- If your TV is compatible with progressive scan (480p), you are recommended to use the HDMI or component video cable (commercially available) to connect this unit to the TV. (Refer to pages 16-17.) If not, use the RCA video cable and set the progressive scan to "OFF" or press and hold **[SETUP]** for more than 3 seconds during DVD playback.
- When selecting "No" or not pressing any buttons on the unit or remote control within 15 seconds at step 3, progressive scan remains to be "OFF" (interlace scan).

### 2 TV Aspect (Default: 4:3 Letter Box)

You can select the TV aspect ratio to match the formats of what you are playing back or watching digital TV broadcasting with the unit and your TV screen (4:3 standard or 16:9 widescreen TV).

Use **[▲ / ▼]** to select a setting, then press **[OK]**.

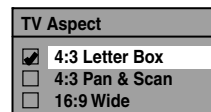

**If you have a standard TV:**

Select "4:3 Letter Box", so that black bars appear on the top and bottom of the TV screen when playing back a wide-screen picture. Select "4:3 Pan & Scan" for a full height picture with both sides trimmed when playing back wide-screen picture.

**If you have a widescreen TV:**

Select "16:9 Wide".



**1** Press [SETUP] in stop mode and use [▲ / ▼] to select “General Setting”, then press [OK].

**2** Use [▲ / ▼] to select “HDMI”, then press [OK].

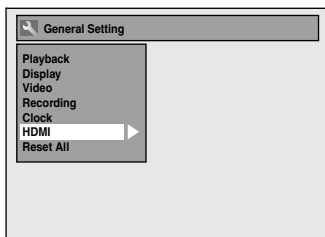

- You cannot select HDMI when an HDMI cable is not connected and the items are shown in grey color.

**3** Use [▲ / ▼] to select a desired item, then press [OK].

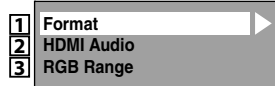

**4** When you finish with the setting, press [SETUP] to exit.

### 1 Format (Default : RGB)

You can select the color space for HDMI output. Set the appropriate color space for your display device.

Use [▲ / ▼] to select a setting, then press [OK].

- When the connected device is not compatible with the Y/Cb/Cr, HDMI signal is output as RGB regardless of the setting.

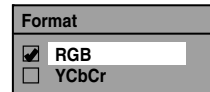

Your setting will be activated.

### 2 HDMI Audio (Default : ON)

If you do not want to output the audio through HDMI (when you digitally output the audio through the COAXIAL DIGITAL AUDIO OUT jack to your audio system, etc.), you can set the HDMI audio output off.

Use [▲ / ▼] to select a setting, then press [OK].

- Set to “OFF” when the HDMI sound is not output.

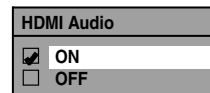

Your setting will be activated.

### 3 RGB Range (Default : Normal)

You can adjust the RGB range to make the dark areas of the HDMI images brighter.

Use [▲ / ▼] to select a setting, then press [OK].

- Select “Enhanced” if the black-white contrast is not clear.
- This setting is effective only for HDMI RGB output.

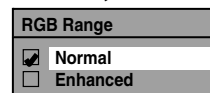

Your setting will be activated.

## Reset All

Reset the setting to default.



**1** Press [SETUP] and use [▲ / ▼] to select "General Setting", then press [OK].  
"General Setting" menu will appear.

**2** Use [▲ / ▼] to select "Reset All", then press [OK].

**3** Select "Yes" using [▲ / ▼], then press [OK].

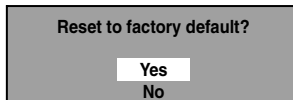

**4** Select "Yes" again using [▲ / ▼], then press [OK].

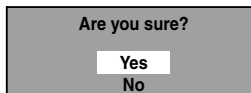

Your setting in recording will be initialized.

### Note

- The settings listed below will remain unchanged even after resetting to the factory default.
- OSD language setting
- Clock setting
- Parental lock setting
- Timer programming information



# VCR FUNCTIONS

## Information on VCR Functions

### Caution on using S-video, component or HDMI connection for VCR:

- Only the playback audio / video are available with these connections.
- Under the condition listed below, the playback image cannot be viewed. Use the standard video connection, in such case;
  - during DVD recording.
- HDMI video resolution cannot be changed when the unit is in VCR mode.

## Playback



Press [VCR] first.

- 1) Insert a prerecorded tape (refer to page 24 on "How to Insert a Disc / Cassette Tape").
- 2) Press [▶] to start playback.
- 3) Press [■] to stop playback.

### To pause playback:

Press [II].

Playback will pause and sound will be muted.

### To resume playback:

Press [▶].

### Note

- When a cassette tape without erase-protection tab is inserted, the unit will start playback automatically.
- Tracking will be automatically adjusted upon playback. To adjust the tracking manually, press [TRACKING ▲ / ▼] on the remote control.
- S-VHS cassette tape is not to be used on this unit.
- Playback will stop when you change the output mode.

## Recording



Press [VCR] first.

- 1) Insert a recordable tape with an erase-protection tab intact.

### Accidental erasure prevention

To prevent accidental recording on a recorded cassette tape, remove its erase-protection tab. To record on it later, cover the hole with cellophane tape.



- 2) Select the recording mode using [REC MODE].

- The desired recording mode is selected in SP (standard play) or SLP (super long play) mode by pressing [REC MODE].

### Recording mode:

Tape speed	Recording / playback time		
	Type of tape	T60	T120
SP mode	1hour	2hours	2-2/3hours
SLP mode	3hours	6hours	8hours

- 3) Press [INPUT SELECT] to select the appropriate external input position (L1/L2) to which your external tuner is connected.

- 4) Press [REC] to start recording.

Press [■] to stop the recording.

### To pause recording:

Press [II].

### To resume recording:

Press [II] or [REC].

After the unit has been in pause mode for 5 minutes, it will stop automatically to protect the tape and the video head from damage.

- Refer to pages 31-34 for instructions on "TIMER RECORDING".

### Note

- This function is available only when the unit is connected by the VIDEO OUT jack.

# VCR FUNCTIONS

## One-touch Timer Recording (OTR)



This feature allows you to set the recording length simply by pressing [REC] on the remote control.

**Press [VCR] first.**

- 1) Insert a recordable tape with an erase-protection tab intact.
- 2) Select the recording mode using [REC MODE].  
(Refer to "Note for DVD to VCR duplication" on page 40 and "Recording" on page 81.)
- 3) Press [INPUT SELECT] to select the appropriate external input position (L1/L2) to which your external tuner is connected.
- 4) Press [REC] to begin the one-touch timer recording.  
You can select a fixed recording time by pressing [REC] repeatedly.

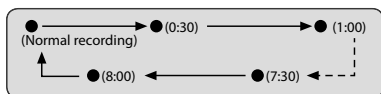

**When the one-touch timer recording is finished, the unit will turn to the standby mode automatically.**

**To change the recording length during the one-touch timer recording:**

Press [REC] repeatedly until the desired length appear.

**To cancel the one-touch timer recording within the specified time:**

Press [■].

### Note

- The remaining recording time will be displayed on the front panel display during one-touch timer recording. Press [DISPLAY] to see it on the TV screen.
- **You cannot pause the one-touch timer recording.**
- If VCR one-touch timer recording is completed during DVD playback or recording, the VCR will be in stop mode and the DVD keeps the current mode.
- Unlike a timer recording, you can perform the following operations during the one-touch timer recording.
  - Turning the power to the standby mode to stop one-touch timer recording.
  - Using [REC] or [■] on the remote control.
- When the one-touch timer recording is finished and the power is in the standby mode, the unit will switch to the timer standby mode automatically if a timer recording has been programmed. Press [TIMER SET] to cancel the timer standby mode for using the unit continuously.
- This function is available only when the unit is connected by the VIDEO OUT jack.

## Index Search



An index mark will be assigned at the beginning of each recording you make. You may skip to a specific marked point by following the steps below.

**Press [VCR] first.**

- 1) Press [SEARCH] so that "INDEX SEARCH" menu appears.
- 2) Using [the Number buttons], enter the number of recordings you wish to skip within 30 seconds.

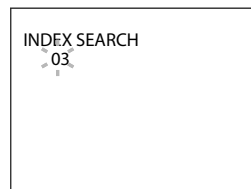

**3) Press [◀], [▶] to start index search.**

If you want to go in the forward direction, press [▶].

If you want to go in the reverse direction, press [◀].

After index search, the VCR will play back the cassette tape automatically.

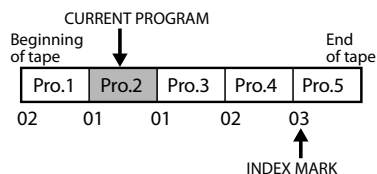

### Note

- You can make the index mark up to 20.
- This function is available only when the unit is connected by the VIDEO OUT jack.

## Time Search



This feature allows you to go to a specific point on a cassette tape by entering the exact amount of time you wish to skip in order to reach the point.

**Press [VCR] first.**

1) Press [SEARCH] repeatedly so that "TIME SEARCH" menu appears.

2) Using [the Number buttons], enter your desired time to skip within 30 seconds.

You can set the time up to 9:59.

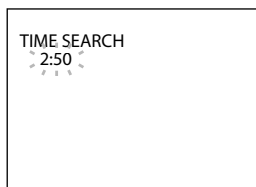

3) Press [◀], [▶] to start time search.

If you want to go in the forward direction, press [▶].

If you want to go in the reverse direction, press [◀].

After time search, the unit will play back the cassette tape automatically.

### Note

- Index search and time search are not available during recording.
- Press [■] to stop the search.
- If the end of the cassette tape is reached during search, this unit will cancel the search and rewind the cassette tape.
- This function is available only when the unit is connected by the VIDEO OUT jack.

## Other Operations



**Press [VCR] first.**

**Fast forward:**

When the unit is in stop mode, press [▶▶] to fast forward the cassette tape.

**Rewind:**

When the unit is in stop mode, press [◀◀] to rewind the cassette tape.

**To cue or review picture during playback (picture search):**

Press [◀◀], [▶▶] during playback.

Press it again and the unit will search in super high speed. (in the SLP mode only)

**To freeze the picture on TV screen during playback (still mode):**

Press [III]. Each time you press the button, the picture will be forwarded by one frame.

If the picture begins to vibrate vertically during the still mode, stabilize the picture by pressing [TRACKING ▲ / ▼] on remote control.

**Counter reset:**

Press [CLEAR] to reset the counter to "0:00:00".

**To playback in slow motion:**

Press [II] during playback, then press [▶▶].

Press [▶▶] or [◀◀] repeatedly to select the desired speed.

**Automatic rewind:**

When a cassette tape is played back or fast forwarded to its end, the cassette tape will rewind to the beginning, stop and eject itself.

**When you playback a cassette tape recorded in Hi-Fi stereo:**

Press [AUDIO] on the remote control to select Hi-Fi or MONO for playback sound mode.

- If you have connected a stereo TV to this unit, select "HIFI".
- If you have connected a monaural TV to this unit, select "MONO".

Your Selection	HIFI		MONO
	L-channel	R-channel	
Type of recorded tape			
non Hi-Fi tapes	Monaural	Monaural	Monaural
Hi-Fi tapes recorded in Hi-Fi stereo	L	R	L+R
Hi-Fi tapes recorded main audio program	Main audio program	Main audio program	Main audio program
Hi-Fi tapes recorded second audio program	Second audio program	Second audio program	Second audio program

### Note

- Still/slow mode will stop after 5 minutes to prevent damage to the cassette tape and the video heads.
- To return to playback from the picture search/still/slow mode, press [▶].

# TROUBLESHOOTING

Before requesting service for this unit, check the table below for a possible cause of the problem you are experiencing. Some simple checks or a minor adjustment on your part may eliminate the problem and restore proper operation.

	Remedy	
GENERAL	The power does not turn on.	<ul style="list-style-type: none"> <li>• Check that the AC power cord is connected securely.</li> <li>• Check the breaker (in case of power failure).</li> <li>• Press <b>[TIMER SET]</b> to cancel the timer standby mode.</li> </ul>
	There is no picture.	<ul style="list-style-type: none"> <li>• Re-connect the connecting cords securely.</li> <li>• Check if the connecting cords are damaged.</li> <li>• Check the connection to your TV (pages 15-18).</li> <li>• Switch the input selector on your TV (such as to "L1") so that the signal from the unit appears on the TV screen.</li> </ul>
	Cannot record a TV program.	<ul style="list-style-type: none"> <li>• This unit does not have a tuner to receive TV broadcasting.</li> <li>• You must connect this unit to an external tuner to record TV programs (page 15).</li> </ul>
	There is no sound or the sound is distorted.	<ul style="list-style-type: none"> <li>• Re-connect all connections securely.</li> <li>• Check if the connecting cord is damaged.</li> <li>• Check the connections to the amplifier input.</li> <li>• Check if the input device setting on the amplifier is correct.</li> <li>• When the unit is in pause mode or in slow-motion playback mode, sound is not output. This is not a malfunction.</li> <li>• When the unit is in fast forward or fast reverse mode, sound is not output. This is not a malfunction.</li> <li>• While the setup menu or timer programming display is shown or while the screen saver is active, the audio is muted.</li> </ul>
	The remote control does not function.	<ul style="list-style-type: none"> <li>• Batteries are weak.</li> <li>• There are obstacles between the remote control and the unit.</li> <li>• The remote control is far from the unit.</li> <li>• There are no batteries in the remote control.</li> <li>• Check if the unit is turned on.</li> <li>• Check if you are pointing the remote control at the recorder and NOT the TV. If you have a plasma TV, it may interfere with the IR signal. Try the remote with the plasma off. If the remote works, you may need to move the unit away from the plasma TV.</li> <li>• Press <b>[DVD]</b> or <b>[VCR]</b>, whichever you need. Then, try again.</li> <li>• Press <b>[TIMER SET]</b> to cancel the timer standby mode.</li> </ul>
	The unit does not operate properly.	<ul style="list-style-type: none"> <li>• When static electricity, etc., causes the unit to operate abnormally, unplug the unit and then plug it in again.</li> </ul>
DVD • VCR	Playback picture is distorted.	<ul style="list-style-type: none"> <li>• Keep the device which may cause electrical disturbances, such as a cellular phone, away.</li> </ul>
	Nothing was recorded even though you set the timer setting correctly.	<ul style="list-style-type: none"> <li>• There was a power failure during recording.</li> <li>• The unit's internal clock stopped due to a power failure that lasted for more than 30 seconds. Reset the clock (page 26).</li> <li>• The program contains copy protection signals that restricts copying.</li> <li>• The timer setting overlapped with another setting that has priority.</li> </ul>
	Timer recording is not complete or did not start from the beginning.	<ul style="list-style-type: none"> <li>• The timer setting overlapped with another setting that has priority (page 34).</li> <li>• Disc space was not enough.</li> </ul>
	Timer recording is impossible.	<ul style="list-style-type: none"> <li>• Make sure  appears on the front panel display of this unit. If not, press <b>[TIMER SET]</b>.</li> </ul>
	No image from HDMI connection.	<ul style="list-style-type: none"> <li>• Check the HDMI connection. (Check the status of the HDMI related indications.)</li> <li>• Check whether the connected monitor device or other device supports HDCP. (This unit will not output a video signal unless the other device supports HDCP.)</li> <li>• Check the setting of HDMI.</li> <li>• Check whether the output format of this unit (HDMI FORMAT) matches the supported input format of the other connected device.</li> <li>• If the unit is connected to the unauthorized display device with an HDMI cable, the audio/video signal may not be output when playing back a commercial DVD-video.</li> </ul>

Instructions continue on the next page.

# TROUBLESHOOTING

	Symptom	Remedy
DVD • VCR	There is no sound or the sound is distorted.	<ul style="list-style-type: none"> <li>• The HDMI sound is not output when "HDMI Audio" is set to "OFF".</li> <li>• Check the RCA audio cable connection. If you are using HDMI-DVI conversion cable, you must connect the RCA audio cable, too.</li> <li>• Check whether the output format of this unit (HDMI FORMAT) matches the supported input format of other connected device.</li> </ul>
	Setup menu cannot be called up.	<ul style="list-style-type: none"> <li>• Setup menus cannot be called up during DVD recording or DVD playback.</li> </ul>
DVD	There is no picture.	<ul style="list-style-type: none"> <li>• If the main menu appears on the TV screen, press <b>[RETURN]</b> to exit.</li> <li>• Check if the progressive scan mode is set correctly according to your TV (page 78).</li> </ul>
	Picture noise appears.	<ul style="list-style-type: none"> <li>• Clean the disc with a cleaning cloth.</li> </ul>
	There is no sound.	<ul style="list-style-type: none"> <li>• If you are using DIGITAL AUDIO OUT (COAXIAL) jack, check the setting in "Disc Audio" (pages 75-76).</li> <li>• Clean the disc with a cleaning cloth.</li> </ul>
	Sound is noisy.	<ul style="list-style-type: none"> <li>• Clean the disc with a cleaning cloth.</li> </ul>
	No DTS sound is output.	<ul style="list-style-type: none"> <li>• This unit is not compatible with DTS sound.</li> </ul>
	The disc does not play back.	<ul style="list-style-type: none"> <li>• No disc is inserted.</li> <li>• A blank disc is inserted.</li> <li>• The disc is upside down. Insert the disc with the labeled side facing up.</li> <li>• The disc is not correctly inserted.</li> <li>• The unit cannot play back certain discs (such as a CD-ROM) (page 44).</li> <li>• The region code on the DVD-video does not match the unit (page 44).</li> <li>• Moisture has condensed inside the unit. Remove the disc and leave the unit turned on for about 2 hours until the moisture evaporates (page 3).</li> <li>• If the disc was recorded on another recorder, the unit cannot play back the disc if it was not finalized.</li> </ul>
	Discs recorded on this unit cannot be played back on other DVD players.	<ul style="list-style-type: none"> <li>• If you are using DVD-RW/-R, please ensure you finalized the disc after recording (pages 42-43).</li> </ul>
	The disc does not start playback from the beginning.	<ul style="list-style-type: none"> <li>• Resume playback was activated (page 50). Press <b>[■]</b> twice.</li> <li>• You have inserted a disc whose title menu or DVD menu automatically appears on the TV screen when it is first inserted.</li> </ul>
	The unit starts playing back the disc automatically.	<ul style="list-style-type: none"> <li>• The DVD-video features an auto playback function.</li> </ul>
	Some functions such as stop, search or slow-motion playback cannot be performed.	<ul style="list-style-type: none"> <li>• Depending on the disc, you may not be able to do some of the operations. Refer to the instruction manual supplied with the disc.</li> </ul>
	The language for the sound track cannot be changed.	<ul style="list-style-type: none"> <li>• The title does not have the multilingual audio tracks.</li> <li>• The DVD-video prohibits the changing of the language for the sound track.</li> </ul>
	The subtitle language cannot be changed or turned off.	<ul style="list-style-type: none"> <li>• Multilingual subtitle are not recorded on the DVD-video.</li> </ul>
	The camera angles cannot be changed.	<ul style="list-style-type: none"> <li>• Multi-angles are not recorded on the DVD-video being played back.</li> <li>• The angle-change operation is available whenever the disc contains a multi-angle feature. Actual change will be performed when the feature comes up.</li> <li>• The DVD-video prohibits changing angles.</li> <li>• Try changing the angle using the DVD-video's menu.</li> </ul>
Recording does not stop immediately after you press <b>[■]</b> .	<ul style="list-style-type: none"> <li>• It may take a few seconds for the unit to input disc data before recording stops.</li> </ul>	

Instructions continue on the next page.

# TROUBLESHOOTING

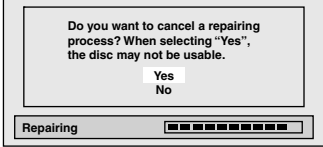
	Symptom	Remedy
DVD	The disc tray does not open when you press [▲].	<ul style="list-style-type: none"> <li>It may take a few seconds for the disc tray to open after you have recorded or edited a disc. This is because the unit is adding disc data to the disc.</li> </ul>
	<p>"Repairing" appears on the TV screen.</p>  <p>In a case you intend to cancel the repairing process.</p> 	<ul style="list-style-type: none"> <li>If there is a power failure or unplugging during recording, finalizing, formatting or editing (even after "Repairing" disappears), a repairing process will begin automatically just after turning the unit on again. It may take several minutes up to about several hours.</li> <li>If you intend to cancel the repairing process, press [▲] on the front panel, then select "Yes" and press [OK]. After that, press [▲] to take out the disc. <b>The disc cancelled during the repairing process MAY NOT work.</b></li> </ul>
VCR	Picture noise appears.	<ul style="list-style-type: none"> <li>Head cleaning for VCR may be necessary. Refer to "Auto head cleaning" (page 4).</li> <li>Adjust tracking control for better picture by pressing [TRACKING ▲ / ▼] while you are playing back a cassette tape.</li> </ul>
	The cassette tape does not play back.	<ul style="list-style-type: none"> <li>No cassette tape is inserted.</li> </ul>
	Recording does not start after you press [REC].	<ul style="list-style-type: none"> <li>Make sure the cassette tape has an erase-protection tab when you record to a cassette tape. If needed, cover the hole with cellophane tape.</li> </ul>
	The remote control does not function.	<ul style="list-style-type: none"> <li>Check if a cassette tape is in this unit.</li> </ul>
	The motor rotates even when playback / recording is stopped.	<ul style="list-style-type: none"> <li>The motor may rotate for the duration of approximately 5 minutes for efficient operation. This is not a malfunction.</li> </ul>

Instructions continue on the next page.

# TROUBLESHOOTING

Error message	Cause	Solution
Disc Error — Please eject the disc. — Playback feature may not be available on this disc.	<ul style="list-style-type: none"> <li>Unplayable disc is inserted in the unit.</li> <li>The disc is upside down.</li> </ul>	<ul style="list-style-type: none"> <li>Insert the standardized disc which have the marks on page 44.</li> <li>Insert the disc with the labeled side facing up.</li> </ul>
Region Error — Please eject the disc. — Playback is not authorized in your region.	<ul style="list-style-type: none"> <li>Playback is not authorized in the region of the DVD-video which you inserted in the unit.</li> </ul>	<ul style="list-style-type: none"> <li>Insert the DVD-video with region codes 1 or ALL.</li> </ul>
Parental Lock On The current selected parental level prohibits playback.	<ul style="list-style-type: none"> <li>The current selected parental level prohibits playback.</li> </ul>	<ul style="list-style-type: none"> <li>Check "Parental Lock" setting in "Playback" menu (page 75).</li> </ul>
Recording Error This program is not allowed to be recorded.	<ul style="list-style-type: none"> <li>You are trying to record the copy of a prohibited program.</li> </ul>	<ul style="list-style-type: none"> <li>You cannot record a copy of prohibited programs.</li> </ul>
Recording Error This program is not recordable in Video mode.	<ul style="list-style-type: none"> <li>You are trying to record the copy-once program onto the DVD-RW disc in Video mode.</li> </ul>	<ul style="list-style-type: none"> <li>Set "Format Mode" to "VR mode" (pages 59 - 60).</li> </ul>
Recording Error Can not record on this disc.	<ul style="list-style-type: none"> <li>You are trying to record onto the disc which is unrecordable or the disc status is unable to record.</li> <li>The disc is dirty.</li> <li>The disc is damaged.</li> </ul>	<ul style="list-style-type: none"> <li>Insert the recordable disc, and ensure the disc status satisfies the recording requirements (page 27).</li> <li>Clean the disc with a cleaning cloth.</li> <li>Replace the disc.</li> </ul>
Recording Error This program is not allowed to be recorded.	<ul style="list-style-type: none"> <li>You are trying to record the copy-once program onto the DVD-RW disc which is not compatible with CPRM.</li> </ul>	<ul style="list-style-type: none"> <li>Insert the DVD-RW disc in VR mode (ver.1.1 or 1.2 compatible with CPRM).</li> </ul>
Recording Error This disc is protected and not recordable.	<ul style="list-style-type: none"> <li>You are trying to record onto the protected disc which is set in "DVD Menu" menu.</li> </ul>	<ul style="list-style-type: none"> <li>Release the disc protect setting in "DVD Menu" menu (page 41).</li> </ul>
Recording Error Disc is full. (No area for new recording)	<ul style="list-style-type: none"> <li>You are trying to record onto the disc which has no space for recording.</li> </ul>	<ul style="list-style-type: none"> <li>Insert the recordable disc with enough recording space.</li> </ul>
Recording Error You cannot record more than 99 titles on one disc. (The maximum is 99)	<ul style="list-style-type: none"> <li>You are trying to record onto the DVD-RW/-R on which the number of recording titles comes up to the maximum (99).</li> </ul>	<ul style="list-style-type: none"> <li>Delete unnecessary titles (page 63).</li> </ul>
Recording Error You cannot record more than 999 chapters on one disc. (The maximum is 999)	<ul style="list-style-type: none"> <li>You are trying to record onto the VR mode DVD-RW on which the number of recording chapters comes up to the maximum (999).</li> </ul>	<ul style="list-style-type: none"> <li>Delete unnecessary chapter marks (page 67).</li> </ul>
Recording Error You cannot record on this disc as Control Information is full.	<ul style="list-style-type: none"> <li>This disc has no space to write the Control Information when recording or deleting contents.</li> <li>When editing has been repeatedly performed, the control Information area may come up to be full even when the recording area has enough space.</li> </ul>	<ul style="list-style-type: none"> <li>Delete unnecessary titles (page 63).</li> </ul>
Recording Error You cannot record on this disc as Power Calibration Area is full.	<ul style="list-style-type: none"> <li>When recordings are performed repeatedly onto an unstable disc, this area may come up to be full.</li> <li>Every time you insert a disc for recording, the disc's working area will be taken up. And if you repeat this frequently, it will be used up sooner and you may not be able to record fully 49 titles.</li> </ul>	<ul style="list-style-type: none"> <li>Insert a new disc.</li> </ul>
Recording Error This disc is already finalized.	<ul style="list-style-type: none"> <li>You are trying to record onto the disc already finalized.</li> </ul>	<ul style="list-style-type: none"> <li>Undo the finalizing for only a DVD-RW disc (page 42).</li> </ul>

\* If you are still having trouble with the unit after checking "TROUBLESHOOTING", write down the error code and the error description for calling our help line mentioned on the back cover to locate an Authorized Service Center.

# LANGUAGE CODE

Language	Code
Abkhazian	4748
Afar	4747
Afrikaans	4752
Albanian	6563
Amharic	4759
Arabic	4764
Armenian	5471
Assamese	4765
Aymara	4771
Azerbaijani	4772
Bashkir	4847
Basque	5167
Bengali;Bangla	4860
Bhutani	5072
Bihari	4854
Bislama	4855
Breton	4864
Bulgarian	4853
Burmese	5971
Byelorussian	4851
Cambodian	5759
Catalan	4947
Chinese	7254
Corsican	4961
Croatian	5464
Czech	4965
Danish	5047
Dutch	6058
English	5160
Esperanto	5161
Estonian	5166
Faroese	5261
Fiji	5256
Finnish	5255
French	5264
Frisian	5271
Galician	5358
Georgian	5747
German	5051
Greek	5158
Greenlandic	5758
Guarani	5360
Gujarati	5367
Hausa	5447
Hebrew	5569
Hindi	5455

Language	Code
Hungarian	5467
Icelandic	5565
Indonesian	5560
Interlingua	5547
Interlingue	5551
Inupiak	5557
Irish	5347
Italian	5566
Japanese	5647
Javanese	5669
Kannada	5760
Kashmiri	5765
Kazakh	5757
Kinyarwanda	6469
Kirghiz	5771
Kirundi	6460
Korean	5761
Kurdish	5767
Laothian	5861
Latin	5847
Latvian; Lettish	5868
Lingala	5860
Lithuanian	5866
Macedonian	5957
Malagasy	5953
Malay	5965
Malayalam	5958
Maltese	5966
Maori	5955
Marathi	5964
Moldavian	5961
Mongolian	5960
Nauru	6047
Nepali	6051
Norwegian	6061
Occitan	6149
Oriya	6164
Oromo (Afan)	6159
Panjabi	6247
Pashto; Pushto	6265
Persian	5247
Polish	6258
Portuguese	6266
Quechua	6367
Rhaeto-Romance	6459
Romanian	6461

Language	Code
Russian	6467
Samoaan	6559
Sangho	6553
Sanskrit	6547
Scots Gaelic	5350
Serbian	6564
Serbo-Croatian	6554
Sesotho	6566
Setswana	6660
Shona	6560
Sindhi	6550
Singhalese	6555
Siswat	6565
Slovak	6557
Slovenian	6558
Somali	6561
Spanish	5165
Sundanese	6567
Swahili	6569
Swedish	6568
Tagalog	6658
Tajik	6653
Tamil	6647
Tatar	6666
Telugu	6651
Thai	6654
Tibetan	4861
Tigrinya	6655
Tonga	6661
Tsonga	6665
Turkish	6664
Turkmen	6657
Twi	6669
Ukrainian	6757
Urdu	6764
Uzbek	6772
Vietnamese	6855
Volapuk	6861
Welsh	4971
Wolof	6961
Xhosa	7054
Yiddish	5655
Yoruba	7161
Zulu	7267



## **Analog Audio**

An electrical signal that directly represents sound. Compare this to digital audio which can be an electrical signal, but is an indirect representation of sound. See also "Digital Audio".

## **Aspect Ratio**

The width of a TV screen relative to its height. Conventional TVs are 4:3 (in other words, the TV screen is almost square); widescreen models are 16:9 (the TV screen is almost twice as wide as it is high).

## **Chapter (DVD only)**

Just as a book is split up into several chapters, a title on a DVD is usually divided into chapters. See also "Title".

## **Component Video Output**

Each signal of luminance (Y) and component (P<sub>B</sub>/C<sub>B</sub>, P<sub>R</sub>/C<sub>R</sub>) is independent to output so that you can experience picture color as it is.

Also, due to compatibility with progressive video (480p), you can experience higher-density picture than that in interlace (480i) mode.

## **Digital Audio**

An indirect representation of sound by numbers. During recording, the sound is measured at discrete intervals (44,100 times a second for CD audio) by an analog-to-digital converter, generating a stream of numbers. On playback, a digital-to-analog converter generates an analog signal based on these numbers. See also "Sampling Frequency" and "Analog Audio".

## **Dolby Digital**

The system to compress digital sound developed by Dolby Laboratories. It offers you sound of stereo(2ch) or multi channel audio.

## **Finalize**

To make DVD, which have been recorded on, possible to play back in DVD players. With this unit, it is possible to finalize DVD-RW, and DVD-R.

## **HDMI™ (high definition multimedia interface)**

A digital interface between audio and video source. It can transmit component video, audio, and control signal with one cable connection.

## **JPEG (joint photographic experts group)**

JPEG is a method of compressing still image files. You can copy JPEG files on CD-RW/-R from a computer and play back the files on this unit.

## **PCM (pulse code modulation)**

The most common system of encoding digital audio, found on CD and DAT. Excellent quality, but requires a lot of data compared to formats such as Dolby Digital and MPEG audio. For compatibility with digital audio recorders (CD, MD and DAT) and AV amplifiers with digital inputs, this unit can convert Dolby Digital and MPEG audio to PCM. See also "Digital Audio".

## **Progressive Scan (480p)**

A type of display that does not split each frame into fields, and instead scans directly through all the scan lines of each frame in order. Progressive scan provides less flickering and higher image resolution than traditional (480i) TV signals. Refer to page 78 for instructions on selective progressive scan mode.

## **Region Code**

Regions associate discs and players with particular areas of the world. This unit will only play back discs that have compatible region codes. You can find the region code of your unit by looking on the rear panel. Some discs are compatible with more than one region (or all regions).

## **Sampling Frequency**

The rate which sound is measured by a specified interval to turn into digital audio data. The numbers of sampling in one second defines as sampling frequency. The higher the rate, the better the sound quality.

## **S-Video Output**

It delivers independently each signal of color(C) and luminance(Y) to TV as video signals, so that higher-quality picture will be gained.

## **Title (DVD only)**

A collection of chapters on DVD. See also "Chapter".

## **Track**

Audio CD use tracks to divide up the content of a disc. The DVD equivalent is called a chapter. See also "Chapter".

## **Video mode**

Video mode is the same recording format as used on the DVD videos you purchase in local shops. You can play back the discs recorded in this format in most DVD players, however it offers only limited editing. You will need to finalize discs recorded in video mode before playing them back on other units.

## **VR mode**

A basic recording format for DVD-RW. VR mode offers advanced editing, however it is playable only on VR mode compatible unit. Finalization is recommended before playing them back on other units.

# SPECIFICATIONS

## General

VCR video heads	Four heads
Power requirements	120V AC, 60Hz
Power consumption	30W (standby: 3.8W)
Dimensions (width x height x depth)	17.2 x 4.0 x 10.3 inches (435 x 99.5 x 260mm)
Weight	9.33 lbs. ( 4.23kg )
Operating temperature	41°F (5°C) to 104°F (40°C)
Operating humidity	Less than 80% (no condensation)

## Recording

Recording format	-VR (video recording) format, Video format
Recording discs	DVD-Rewritable, DVD-Recordable

### Video recording format

Sampling frequency	13.5 MHz
Compression format	MPEG

### Audio recording format

Sampling frequency	48 kHz
Compression format	Dolby Digital

## Terminals







	Front			
<b>Audio input</b>	RCA jack x 2	2V rms (input impedance: more than 22kΩ)		
<b>Video input</b>	RCA jack x 1	1Vp-p (75Ω)		
<b>S-video input</b>	Mini DIN 4-pin x 1	Y: 1Vp-p (75Ω)	C: 286mVp-p (75Ω)	
<b>Audio input</b>	RCA jack x 2	2V rms (input impedance: more than 22kΩ)		
<b>Audio output</b>	RCA jack x 4	2V rms (output impedance: more than 1kΩ)		
<b>Video input</b>	RCA jack x 1	1Vp-p (75Ω)		
<b>Video output</b>	RCA jack x 1	1Vp-p (75Ω)		
<b>S-video input</b>	Mini DIN 4-pin x 1	Y: 1Vp-p (75Ω)	C: 286mVp-p (75Ω)	
<b>S-video output</b>	Mini DIN 4-pin x 1	Y: 1Vp-p (75Ω)	C: 286mVp-p (75Ω)	
<b>Component video out</b>	RCA jack x 3	Y: 1Vp-p (75Ω)	PB/CB: 700mVp-p (75Ω)	PR/CR: 700mVp-p (75Ω)
<b>Coaxial digital audio out</b>	RCA jack x 1	500mVp-p (75Ω)		
<b>HDMI output</b>	HDMI jack x 1			

## Note

- The specifications and design of this product are subject to change without notice.

## Discos Reproducibles

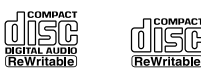
Este aparato es compatible con la reproducción de los siguientes discos y archivos.

Discos reproducibles	Logotipos
DVD-video	
DVD-RW (Modo de VR o Video)	
DVD-R (Modo de Video)	
CD-DA (CD de audio)	
CD-RW	
CD-R	
KODAK Picture CD	
Archivos reproducibles	Soportes
JPEG	CD-RW/-R

 es una marca registrada de DVD Format/Logo Licensing Corporation.

## Códigos de Región

El número presente en el interior el globo se refiere a una región del mundo. Este aparato puede reproducir discos DVD que estén rotulados para ALL las regiones o para la región 1.



## Disco Grabable

Este aparato puede grabar a DVD-RW y DVD-R. Los discos DVD-R pueden ser grabados sólo una vez. Los discos DVD-RW pueden ser grabados y borrados muchas veces.

**En este aparato los discos DVD-RW/-R serán grabados automáticamente en el modo DVD-VR.**

Logotipos	Atributos
 	Disco de 8 cm / 12 cm, un solo lado, una sola capa
DVD-RW    DVD-R	Tiempo de grabación máx. aprox. (modo SLP):
	360 minutos (4,7 GB) (para 12 cm)
	108 minutos (1,4 GB) (para 8 cm)

• Los siguientes discos se recomiendan para obtener una buena calidad de grabación y han sido comprobados como compatibles con este aparato. Sin embargo, según sea la condición del medio el equipo podría no leer el disco correctamente.

Verbatim	DVD-R 8x,	DVD-RW 2x
JVC	DVD-RW 4x	
Maxell	DVD-R 8x/16x	

El comportamiento de cualquier otro disco no está garantizado.

## Disco no Grabable

- Un DVD-RW grabado en un modo distinto de -VR no será grabable en este aparato a menos que usted borre todo el contenido del disco. (Consulte la página 70.)
- Un DVD-R grabado en un modo distinto de -VR no será grabable en este aparato.

## Conexión Básica

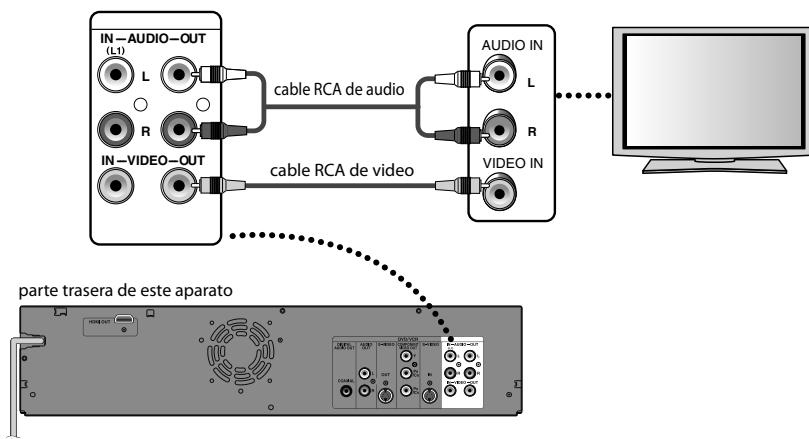

## Conexión a un Televisor con un Puerto Compatible con HDMI™

- HDMI emite las señales de video / audio sin convertirlas en señales analógicas.
- No es necesaria una conexión de audio.

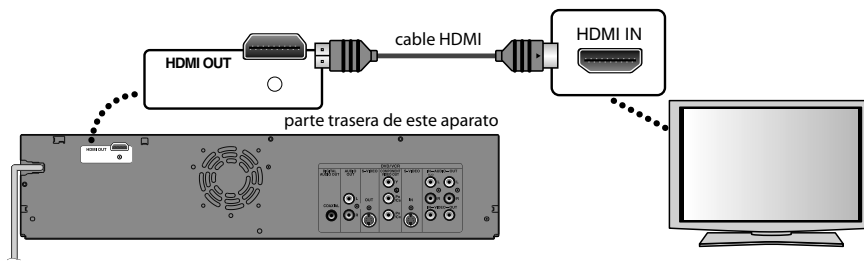

⚠ No incline el conector para introducirlo en la toma HDMI y compruebe que el tipo de toma corresponde con el tipo de conector.

## Modo HDMI y señales efectivas de salida

Presione **[HDMI]** para seleccionar el modo de salida HDMI. Cada vez que se presiona **[HDMI]** el modo de salida varía como sigue.

Pantalla del panel frontal	Señal de salida de video
480P	Progresivo de 480
Presione <b>[HDMI]</b>	↓
720P	Progresivo de 720
Presione <b>[HDMI]</b>	↓
1080i	1080 entrelazado
Presione <b>[HDMI]</b>	↓
1080P	Progresivo de 1080
Presione <b>[HDMI]</b>	

- El modo HDMI que no esté admitido por el dispositivo de exhibición será pasado por alto.

## Configuración Inicial

Cuando usted encienda este aparato por primera vez necesita seguir estos pasos.

**1** Presione [⊕].

Encienda el televisor. Seleccione la entrada a la cual está conectado el aparato.

**2** Utilice [▲ / ▼] para seleccionar su idioma deseado, y luego presione [OK] para establecerlo.

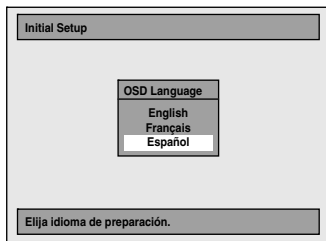

**3** Presione [OK] para activar "Ajuste Manual de Reloj".

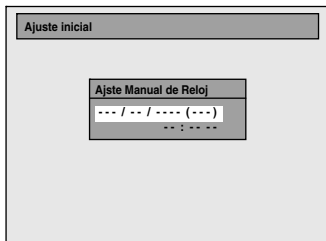

**4** Utilice [◀ / ▶] para seleccionar un elemento a configurar, y utilice [▲ / ▼] para seleccionar el contenido de su preferencia, y luego presione [OK].

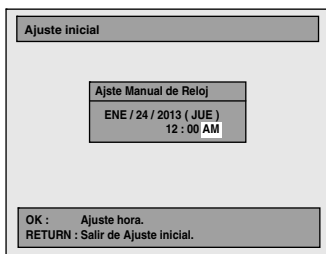

## Grabación Básica

**1** Presione [DVD]. Presione [▲] para abrir la bandeja de discos e insertar su disco con el rótulo apuntando hacia arriba. Presione de nuevo [▲] para cerrar la bandeja de discos.

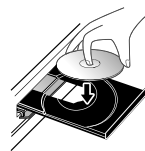

\* Asegúrese de que el disco sea compatible con este aparato. (Para obtener la lista de discos compatibles consulte la página 91.)

**2** Para seleccionar un modo de grabación presione [REC MODE].

Modo de grabación	Tiempo de grabación		Calidad del vídeo y el sonido
	Disco de 8 cm	Disco de 12 cm	
XP (1Hr)	18 min	60 min	Buena ↑ ↓ Deficiente
SP (2Hr)	36 min	120 min	
LP (4Hr)	72 min	240 min	
EP (6Hr)	108 min	360 min	
SLP (8Hr)	144 min	480 min	

**3** Presione [INPUT SELECT] para seleccionar la posición adecuada de la entrada externa (L1/L2) a la cual está conectado su sintonizador externo. Luego seleccione en el sintonizador externo el canal que desea grabar.

**4** Presione [REC] para iniciar la grabación.

**Para configurar la grabación a un toque con temporizador (OTR)...**

Esta es una manera sencilla de configurar el tiempo de grabación en bloques de 30 minutos.

Presione [REC] repetidamente hasta que aparezca en la pantalla del televisor la longitud deseada de grabación (30 minutos a 6 horas).

Comenzará la grabación a un toque con temporizador.

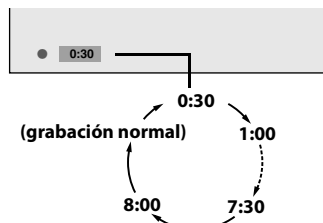

**Para cambiar la duración de la grabación durante la grabación a un toque con temporizador:**

Presione [REC] repetidamente hasta que aparezca la duración deseada.

**Para cancelar la grabación a un toque con temporizador dentro del tiempo especificado:**

Presione [■].

**5** Para de tener la grabación presione [■].

## Grabación con Temporizador

Usted puede programar el equipo para que grabe hasta 12 programas, con un mes de anticipación. También hay disponibles grabaciones de programas diarias o semanales.

### Antes de grabar, asegúrese de que

- Antes de establecer una programación del temporizador configure el reloj.
- Inserte un disco grabable con suficiente espacio libre o una cinta de cassette con una lengüeta de grabación.



**1** Presione [TIMER].

**2** Utilice [▲ / ▼] para seleccionar "Prog. nuevo", y luego presione [OK].

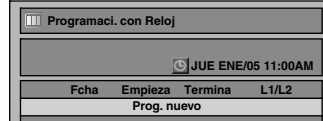

**3** Configure una programación del temporizador.

**4** Presione [OK].

**5** Presione [TIMER SET] para configurar una programación del temporizador. Aparecerá en el pantalla del panel frontal.

Configure la fecha.

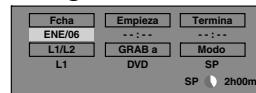

Configure las horas de inicio y finalización.

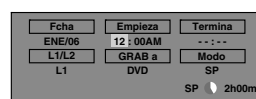

Seleccione la posición adecuada de la entrada externa (L1/L2) a la cual está conectado su sintonizador externo.

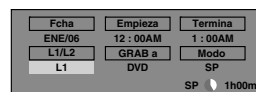

Seleccione un medio de grabación ("DVD" o "VCR").

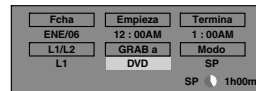

Seleccione un modo de grabación.

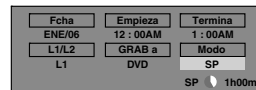

## Reproducción

**1** Presione [DVD].



**2** Abra la bandeja de discos, y Inserte un disco.



**3** Cerrar la bandeja de discos.



**4** Comience a reproducir.



**5** Detenga la reproducción.



Introduction

Connections

Basic Setup

Recording

Playback

Editing

Function Setup

VCR Functions

Others

Español

# FUNAI

## LIMITED WARRANTY

FUNAI CORP. will repair this product, free of charge in the USA in the event of defect in materials or workmanship as follows:

### **DURATION:**

**PARTS:** FUNAI CORP. will provide parts to replace defective parts without charge for one (1) year from the date of original retail purchase. Certain parts are excluded from this warranty.

**LABOR:** FUNAI CORP. will provide the labor without charge for a period of ninety (90) days from the date of original retail purchase.

**Note:** Any product sold and identified as refurbished or renewed carries a ninety (90) days labor and parts limited warranty.

### **LIMITS AND EXCLUSIONS:**

THIS WARRANTY IS EXTENDED ONLY TO THE ORIGINAL RETAIL PURCHASER. A PURCHASE RECEIPT OR OTHER PROOF OF ORIGINAL RETAIL PURCHASE WILL BE REQUIRED TOGETHER WITH THE PRODUCT TO OBTAIN SERVICE UNDER THIS WARRANTY.

This warranty shall not be extended to any other person or transferee.

This warranty is void and of no effect if any serial numbers on the product are altered, replaced, defaced, missing or if service was attempted by an unauthorized service center. This limited warranty does not apply to any product not purchased and used in the United States.

This warranty only covers failures due to defects in material or workmanship which occur during normal use. It does not cover damage which occurs in shipment, or failures which are caused by repairs, alterations or products not supplied by FUNAI CORP., or damage, which results from accident, misuse, abuse, mishandling, misapplication, alteration, faulty installation, improper maintenance, commercial use such as hotel, rental or office use of this product, or damage which results from fire, flood, lightning or other acts of God.

THIS WARRANTY DOES NOT COVER PACKING MATERIALS, ANY ACCESSORIES (EXCEPT REMOTE CONTROL), ANY COSMETIC PARTS, COMPLETE ASSEMBLY PARTS, DEMO OR FLOOR MODELS.

FUNAI CORP. AND ITS REPRESENTATIVES OR AGENTS SHALL IN NO EVENT BE LIABLE FOR ANY GENERAL, INDIRECT OR CONSEQUENTIAL DAMAGES ARISING OUT OF OR OCCASIONED BY THE USE OF OR THE INABILITY TO USE THIS PRODUCT. THIS WARRANTY IS MADE IN LIEU OF ALL OTHER WARRANTIES, EXPRESS OR IMPLIED, AND OF ALL OTHER LIABILITIES ON THE PART OF FUNAI, ALL OTHER WARRANTIES INCLUDING THE WARRANTY OF MERCHANTABILITY AND FITNESS FOR A PARTICULAR PURPOSE, ARE HEREBY DISCLAIMED BY FUNAI AND ITS REPRESENTATIVES IN THE UNITED STATES.

ALL WARRANTY INSPECTIONS AND REPAIRS MUST BE PERFORMED BY AN AUTHORIZED SERVICE CENTER. THIS WARRANTY IS ONLY VALID WHEN THE UNIT IS CARRIED-IN TO AN AUTHORIZED SERVICE CENTER.

**THE PRODUCT MUST BE ACCOMPANIED BY A COPY OF THE ORIGINAL RETAIL PURCHASE RECEIPT.** IF NO PROOF OF PURCHASE IS ATTACHED, THE WARRANTY WILL NOT BE HONORED AND REPAIR COSTS WILL BE CHARGED.

### **IMPORTANT:**

THIS LIMITED WARRANTY GIVES YOU SPECIFIC LEGAL RIGHTS. YOU MAY HAVE OTHER RIGHTS THAT VARY FROM STATE TO STATE. IF, AT ANY TIME DURING THE WARRANTY PERIOD, YOU ARE UNABLE TO OBTAIN SATISFACTION WITH THE REPAIR OF THIS PRODUCT, PLEASE CONTACT FUNAI CORP.

### **ATTENTION:**

FUNAI CORP. RESERVES THE RIGHT TO MODIFY ANY DESIGN OF THIS PRODUCT WITHOUT PRIOR NOTICE.

### **WARRANTY STATEMENT REGARDING NON AUTHORIZED REPAIRS:**

To obtain warranty service, you must take the product, or deliver the product freight prepaid, in either its original packaging or packaging affording an equal degree of protection, to any AUTHORIZED SERVICE CENTER. FUNAI CORP. will not reimburse you for any service done by unauthorized service providers without prior written approval.

**To locate your nearest AUTHORIZED SERVICE CENTER or for general service inquiries, please contact us at:**

**FUNAI SERVICE CORPORATION**  
**Tel: 1-877-39-Funai (1-877-393-8624)**  
**www.funaiamerica.com**  
2200 Spiegel Drive, Groveport, OH 43125

